

OPERATING AND MAINTENANCE MANUAL

Product: **Secondary Current Injection Test Set**

Type: **50ADM-P**

For Software Version v1.3.1601 and later

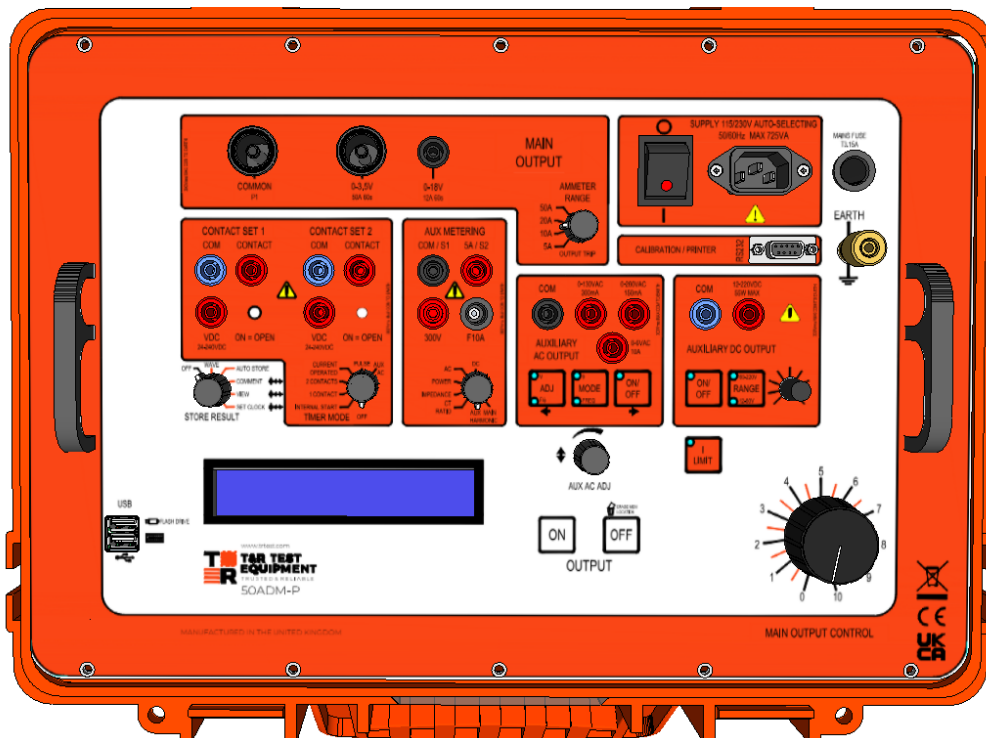

DESIGNED AND MANUFACTURED BY:

T & R Test Equipment Limited

15-16 Woodbridge Meadows, Guildford, Surrey, GU1 1BJ, United Kingdom

Telephone: 01483 207428

e-mail:

sales@trtest.com

Web:

www.trtest.com

GENERAL SAFETY STATEMENT



The following safety precautions should be reviewed to avoid injury to the user and damage to the product (and other products connected to it). To avoid potential hazards only use this product as specified.

- **Only suitably qualified personnel should use this equipment. Servicing of this product should only be carried out by suitably qualified service personnel.**

To Avoid Fire Hazards and Personal Injury

- Use the correct power supply lead. Only use a suitably rated and approved power supply lead for the country of use.
- Ensure that systems that the unit is to be connected to are dead.
- Do not connect and disconnect leads whilst outputs are switched on. Breaking the output circuit with current flowing may cause arcing.
- Ensure that the product is grounded. To avoid electric shock, it is essential that the grounding conductor is connected to the earth ground. An additional earth terminal is provided on the unit that must be connected to a local earth when the unit is used in a substation environment. Ensure that the unit is properly grounded before making any connections to inputs or outputs.
- Terminal ratings must be observed to prevent fire hazards and risk of injury to the operator. Consult the product manual for ratings information before making connections to any terminal.
- It is ESSENTIAL to consult the product manual for rating information before making any connection to a terminal or terminal group marked with a warning triangle.
- Only use fuses of a type and rating specified for this product.
- Do not operate the unit out of its case or with any covers or panels removed.
- Do not touch exposed connections and components when power is present.
- Do not operate the product if any damage is suspected. Refer the unit to qualified service personnel to be checked.
- Do not operate the unit in wet or damp conditions.
- Do not operate the unit in an explosive atmosphere.
- The unit has a high output current (up to 50A), and therefore generates large magnetic fields around the output leads. Care must be taken in siting the unit next to items sensitive to magnetic fields (such as computer monitors and other sensitive equipment).
- Warnings from cardiac pacemaker manufacturers state that strong magnetic fields may affect operation. Any high current unit such as the 50ADM-P should therefore not be operated by, or in the vicinity of persons fitted with cardiac pacemakers or any other electronic or electrical medical implants.

If any further queries occur regarding the usage and maintenance of the equipment detailed in this manual, please refer these to the supplier of the equipment in the first case or to the manufacturer, T & R Test Equipment Limited.

SAFETY TERMS AND SYMBOLS

The following safety symbols appear on the equipment:



CAUTION – Refer to manual



Mains off



Mains on

CONVENTIONS USED IN THIS MANUAL

Text shown in CAPITALS refers directly to labels of controls on the front panel of the unit (e.g. AUX AC ADJ refers to the auxiliary ac adjustment knob).

CONTENTS

1.	DESCRIPTION OF EQUIPMENT	9
1.1	Connections, controls & display	10
1.1.1	Display	12
1.1.2	Warning messages	12
1.2	Installation	13
1.2.1	Environment	13
1.2.2	Supply requirements	13
1.2.3	Connection cable ratings	13
1.2.4	Overload protection	14
1.3	Functions	15
1.3.1	Main current output	15
1.3.2	Current metering	16
1.3.3	Auxiliary AC voltage output	17
1.3.4	Auxiliary DC voltage output	19
1.3.5	Auxiliary metering input	20
1.3.6	Timing system	22
1.3.7	Storage of results	27
2.	OPERATION	31
2.1	Current injection – 1 current	31
2.1.1	AC current injection without timing	31
2.1.2	AC current injection with timing	32
2.1.3	AC current injection with result storage	33
2.2	Current injection – 2 currents	34
2.2.1	AC current injection with timing	34
2.3	Voltage supply – 1 voltage	35
2.3.1	AC voltage output without timing	35
2.3.2	AC voltage step with timing	36
2.4	Voltage supply – 2 voltages	38
2.5	Current injection with phase shift voltage – 1 current & 1 voltage	39
3	APPLICATIONS	40
3.1	Over-current and earth fault relays	40
3.1.1	Pick-up and drop-off test	40
3.1.2	Timing test	41
3.1.3	Timing test with recording of results	42
3.1.3	Drop-off test with timing	43

3.2	Under-current relays	44
3.2.1	Pick-up and drop-off test	44
3.3	Under and over-voltage relays	45
3.3.1	Pick-up and drop-off test	45
3.3.2	Timing of over-voltage relays	46
3.3.3	Timing of under-voltage relays	47
3.4	Under and over frequency relays	49
3.4.1	Pick-up and drop-off test	49
3.4.2	Timing test	50
3.5	Auto reset/re-closing devices	51
3.5.1	Timing a single re-close action with circuit breaker	51
3.5.2	Procedure to time auto re-closing relay	52
3.6	Timing circuit breakers	54
3.7	Directional overcurrent/earth fault relays	55
3.8	Bias differential relays	57
3.9	Check sync relays	58
3.10	Testing induction disk relays using the optional filter	60
3.11	Induction disk relay run-back time	61
4.	MAINTENANCE	62
4.1	Regulator brushes	62
4.2	Removal of the 50ADM-P from case	62
5.	STANDARD ACCESSORIES	63
5.1	Spares fuses supplied:-	63
5.2	Standard accessories supplied	63
5.3	Optional accessories/spares	63
6.	PERFORMANCE SPECIFICATIONS	64
6.1	Accuracy of instrumentation and associated circuit components	64
6.1.1	Main output ammeter	64
6.1.2	Auxiliary metering	64
6.1.3	Timing system	64
7.	REVISION	65

1. DESCRIPTION OF EQUIPMENT

The 50ADM-P is a flexible current injection system capable of supplying currents of up to 50A AC into a variety of loads. The unit is designed for testing devices used for power system protection but can be used wherever a high current AC source is required. The outputs may also be used in voltage mode to supply voltages of up to 18Vac.

The unit has an auxiliary ac output with variable phase and variable frequency. This may be used to supply a voltage up to 260V or a second current (up to 10A) to the device under test.

Accurate metering facilities with a fast capture time and a very flexible timing system are provided. A stabilised auxiliary DC output is provided to provide power to the device under test.

An auxiliary metering input is available, allowing the measurement of voltage, current, frequency, phase, and THD. In conjunction with the main current output this can also measure power and impedance.

Test results from the unit may be stored to a USB memory key and comments entered against the results using a USB keyboard.

The 50ADM-P is designed to be used on 'dead' systems (i.e. no externally supplied voltages are present on the test object). Do not connect the 50ADM-P to a live system. Always check that the power to the device under test is off and the circuit is isolated before making any connections.

1.1 Connections, controls & display

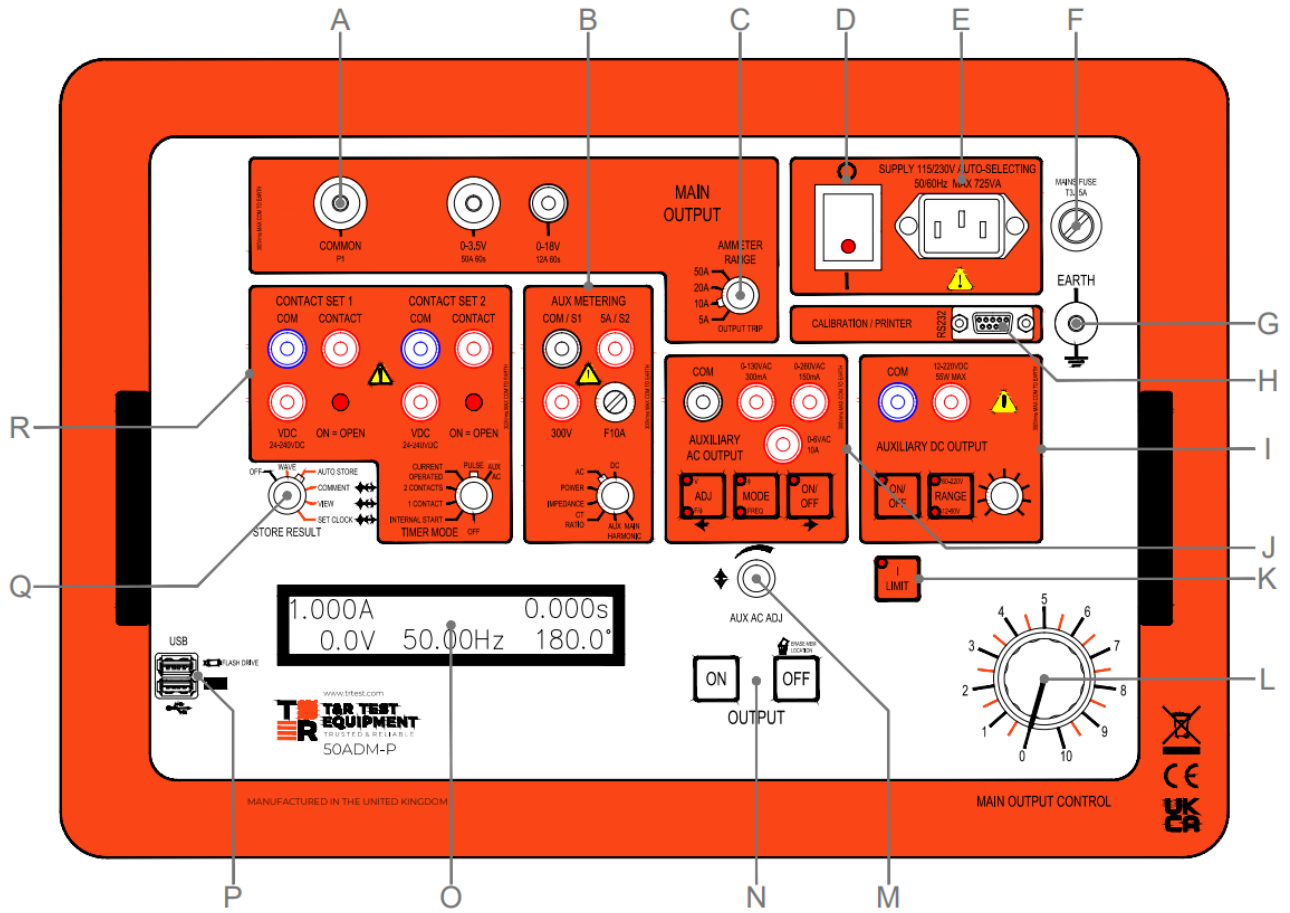

Figure 1.1 50ADM-P front panel

Ref	Item	Function
A	Main output terminals	Main ac outputs for ac tests
B	Auxiliary metering input sockets	Voltage and current input sockets for auxiliary metering
C	Ammeter range switch	Selects ammeter range & trip for main output
D	Mains on/off switch	
E	Mains input connector	Mains supply
F	Mains input fuse	Protection
G	Earth terminal	Connect 50ADM-P to local ground for safety
H	RS232 connector	Serial data output for calibration
I	Auxiliary dc supply	Controls and connectors for auxiliary dc supply
J	Auxiliary ac output	Controls and connectors for phase shifting auxiliary ac supply
K	I limit button	Selects I limit mode for small currents and fine current control
L	Main output control	Controls voltage/current of main output
M	Auxiliary ac adjust control	Digital control to set auxiliary ac voltage, phase and frequency Also used for clock set and viewing comments
N	Main output on/off controls	Switches the main output on & off
O	Display	Main current and auxiliary metering results
P	USB sockets	Upper USB socket for connection of USB memory key. Lower USB socket for connection of keyboard.
Q	Store results control	Set comment, set clock, view stored results, select auto results store mode
R	Timer	Timer contact inputs and mode control

1.1.1 Display

The 50ADM-P display simultaneously shows the injected test current, the timer result and the selected auxiliary input values on the display. It also displays warning and error messages, detailed in section 1.1.2.

<i>Main output current</i>		<i>Timer</i>
0.000A	0.000s	
0.0V	50.00Hz	0.0°

Auxiliary metering values

Figure 1.2 Normal values displayed on screen

1.1.2 Warning messages

Output tripped Press Green to Reset
--

Figure 1.3 Over-current trip warning message

When an over current or duty cycle trip occurs, the green 'off' pushbutton must be pressed to clear the trip condition.

Duty Cycle Trip 15 Minute Timeout

Figure 1.4 Duty cycle trip warning message



Allow the unit to cool for the rated off time for the main output after a duty cycle trip.

Over Temperature Output Disabled

Figure 1.5 Unit over temperature warning message



After an over temperature trip, the unit will automatically reset when the temperature falls to an acceptable level. If the unit is over temperature, switching the unit off and back on will not clear the message – the unit must be allowed to cool.

1.2 Installation

1.2.1 Environment

The 50ADM-P is designed for use in indoor industrial and electrical substation environments.

Maximum altitude: 2000m

Temperature: 0°C to 45°C operating
-20°C to 60°C storage

Relative humidity: 90% non-condensing

Protection rating: IP40 lid closed
IP20 in use

1.2.2 Supply requirements

The 50ADM-P requires a single phase 50/60Hz supply of 115V±10% or 230V ±10%. The correct range is automatically selected. The maximum power requirement of the unit is 725VA. Use only a suitably approved mains lead fitted with a mains connector suitable for the local power supply.

In substation environments the earth terminal on the front panel of the unit should be connected to a low impedance local earth.

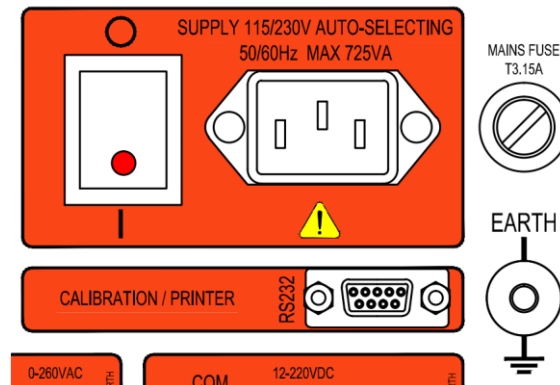

Figure 1.6 Mains input

The mains input is fitted with a T3.15A HRC fuse. This must be replaced with a fuse of the same type.

1.2.3 Connection cable ratings

Main output 10V tap 3.5V 50A CAT I 10-16mmsq terminated in Multi-Contact 6mm connectors

All other inputs/outputs 600V CAT II test leads terminated in shrouded 4mm connectors

1.2.4 *Overload protection*

Location	Protection
Mains supply	T3.15A fuse
Auxiliary ac output	Current trip
Auxiliary dc output	Current limit
Contact circuits	Auto-resetting semiconductor fuses
Main output	Electronic over-current trip Electronic duty cycle trip Thermal protection
Auxiliary metering current input	F10A fuse

1.3 Functions

1.3.1 Main current output

The main current output of the unit has two taps, allowing voltage ranges of 0-3.5V and 0-18V to be selected.

Voltage range	Current rating		
	Continuous	5min on/15 off	1min on/15 off
0-3.5V	16A	32A	50A
0-18V	4A	8A	12A

Each output is rated for a continuous current and higher intermittent currents. The maximum 'on' time for intermittent currents is enforced by the unit, and the output will be switched off if the rating is exceeded. The display will then show Output Tripped Press Green to Reset until the green 'off' button is pressed to clear the trip condition.

The curve for intermittent current ratings is shown in figure 1.1.

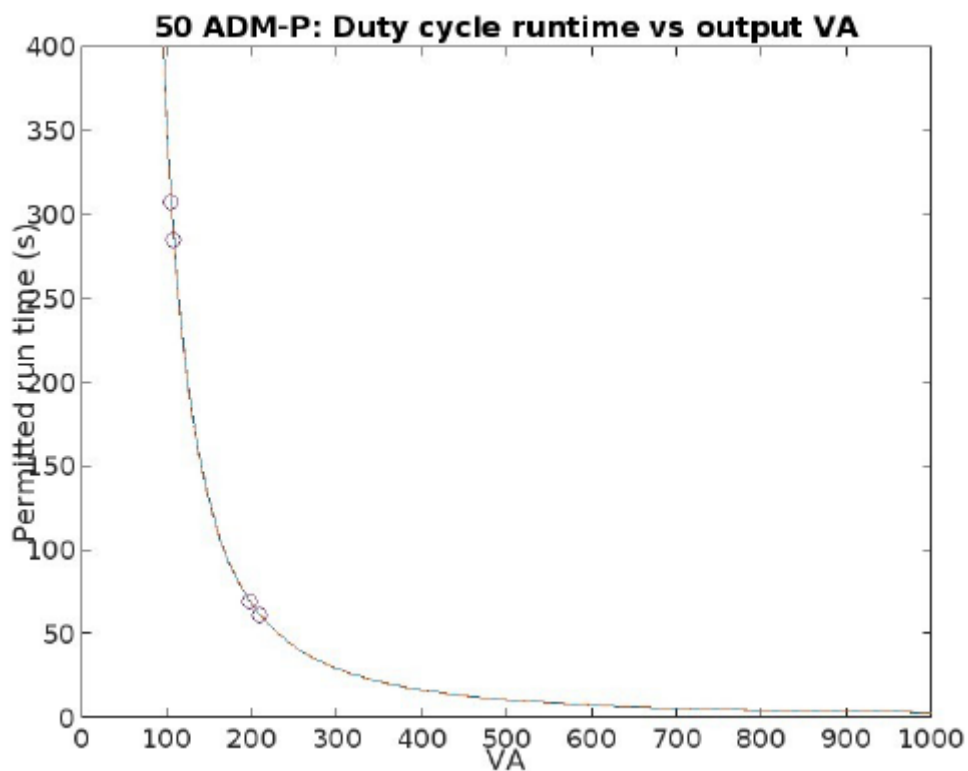

Figure 1.7 50ADM-P maximum 'on' times

1.3.1.1 I limit mode

Current limit mode gives very fine control of currents up to 15A. It also allows fine current control into very low impedance loads such as digital relays. It adds impedance into the output circuit to reduce the maximum current available and allow fine control of small currents. When selected, the LED in the switch illuminates.



Figure 1.8 I limit mode button

Range	Current				Output V
	Short circuit	Continuous	5 minutes on	2 minutes on	Open circuit
3.5V	15A	5A	10A	15A	3.7V
18V	3A	1A	2A	3A	19.6V

The duty cycle trip level is reduced to the levels shown in the table above when I mode is selected.

1.3.2 Current metering

The main output current is metered by a true RMS reading digital memory ammeter with 4 ranges.

Range	Resolution	Accuracy 50Hz	Accuracy 60Hz	Trip current
5.000A	0.001A	$\pm 0.5\%$ rdg $\pm 5d$	$\pm 1\%$ rdg $\pm 5d$	5.25A
10.00A	0.01A	$\pm 0.5\%$ rdg $\pm 5d$	$\pm 1\%$ rdg $\pm 5d$	10.5A
20.00A	0.01A	$\pm 0.5\%$ rdg $\pm 5d$	$\pm 1\%$ rdg $\pm 5d$	21.0A
50.00A	0.01A	$\pm 0.5\%$ rdg $\pm 5d$	$\pm 1\%$ rdg $\pm 5d$	52.5A

The ammeter range is independent of the current output selected. For low output currents I limit mode should be selected to allow fine control. The metering will accurately capture a waveform present for a single cycle. The current reading is held on the display whenever the output switches off. Selecting the correct timing mode for the application ensure that the current is captured (for example current operated mode for a circuit breaker or internal start mode for an IDMT relay).

The unit has an electronic trip circuit that monitors the output current and switches the output off if the trip value exceeds 105% of full scale of the metering range selected.

1.3.3 Auxiliary AC voltage output

The auxiliary AC output has variable voltage, phase and frequency. It has three outputs for testing voltage and current relays.

Voltage range	Current rating		Phase angle	Frequency
	Continuous	5min on/15 off		
0-130V	0.23A	0.46A	-180° to +180°	45-100Hz
0-260V	0.11A	0.23A	-180° to +180°	45-100Hz
0-6V	5A	10A	-180° to +180°	45-100Hz

Use the 130V and 260V outputs for voltage relays. The 0-6V 10A is designed for use as a second current source for testing bias differential relays.

The output is independently switched and isolated. The voltage and current from this output are metered using the auxiliary metering input.

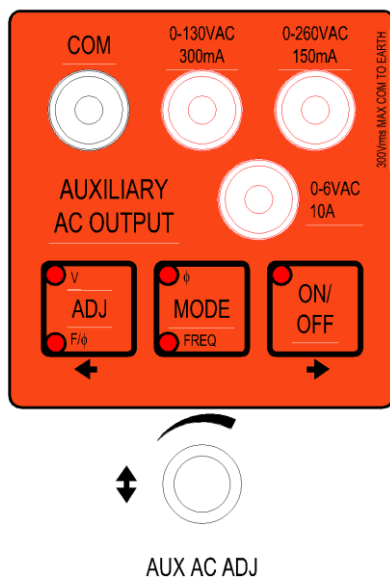

The output is controlled by the aux ac adjust control. The function of this control changes depending on the mode selected.

The ADJ button selects between:

- voltage control (V LED illuminated).
- frequency/phase control (F/Φ LED illuminated).
- other (no LEDs illuminated). This mode is used in result viewing mode to select a value to display.

Pressing the ADJ button repeatedly cycles through these modes.

Pressing the MODE button switches between phase control mode and frequency control mode.

Figure 1.9 Aux ac output



Variable phase mode - voltage adjustment
 AUX AC ADJ changes the output voltage

↓ press ADJ

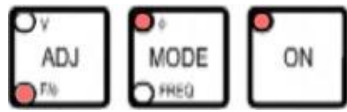

Variable phase mode - phase angle adjustment
 AUX AC ADJ changes the output phase angle

↓ press MODE



Variable frequency mode - frequency adjustment
 AUX AC ADJ changes the output frequency

↓ press ADJ



Other adjustment
 AUX AC ADJ changes parameters for other operations
 (select result to view)

↓ Press ADJ to return to top

Figure 1.10 Aux ac mode select

1.3.4 Auxiliary DC voltage output

A variable stabilised auxiliary DC supply is provided to supply power to the relay under test.

Voltage range	Rating		
	Maximum current	Continuous current	Current limit
12-60V	1A	1A up to 25V reduce to 0.4A at 60V	1.1A
60-220V	0.23A	0.23A up to 108V reduce to 0.11A at 220V	0.3A

1.3.5 Auxiliary metering input

The 50ADM-P has an auxiliary metering input which can be used to measure AC or DC voltage or current, and frequency. In addition, values may be measured using both the main output and auxiliary input: phase angle, impedance, power and CT ratio. The unit also calculates the THD of the output current and auxiliary input.

Two inputs are provided, one for voltages up to 300V and the other for currents up to 10A. The input in use is automatically selected by the unit. **Do not connect to both of the inputs simultaneously.**



Do not exceed the input ratings.

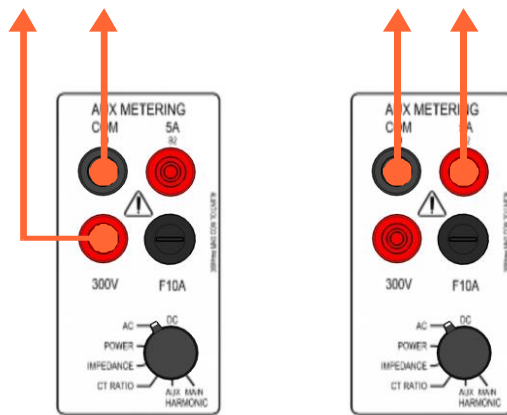

Voltage input

Current input

Figure 1.11 Auxiliary inputs

1.3.5.1 Auxiliary input ranges

0.000A	0.000s
A	B C

Range		Displayed values		
		A	B	C
DC voltage	0-300.0Vdc	DC voltage	-	RMS ripple
AC voltage	0-300.0Vac rms	RMS voltage	Frequency	Phase angle*
AC current	0-5.000Aac rms 5-9.999Aac rms**	RMS current	Frequency	Phase angle*
DC current	0-9.999Adc	DC current	-	RMS ripple
Power	20.00W-60.00kW*	Watts*	VA*	PF 0-1.00*
Impedance	1mΩ-50kΩ*	Resistance (R)*	Reactance (X)*	Phase angle*
CT Ratio	0.10:1-2000:1 0.50:5 9999:5	Ratio for 1A CT***	Ratio for 5A CT***	Phase angle***
Aux harmonic	0-99.9%	Fundamental	-	THD
Main harmonic	0-99.9%	Fundamental	-	THD

* Calculated using main output current and auxiliary metering voltage input

** 0-5.000Arms for CF<3, 0-9.999A for CF<1.5

*** Calculated using main output current and auxiliary metering current input

(CF = Crest Factor)

1.3.5.2 Phase measurement between output current and an external voltage

In AC, power, impedance and CT ratio modes the phase angle is measured between the main output current and auxiliary input. If either the main current or auxiliary input are too small to accurately calculate the phase the reading will be replaced by dashes (----).

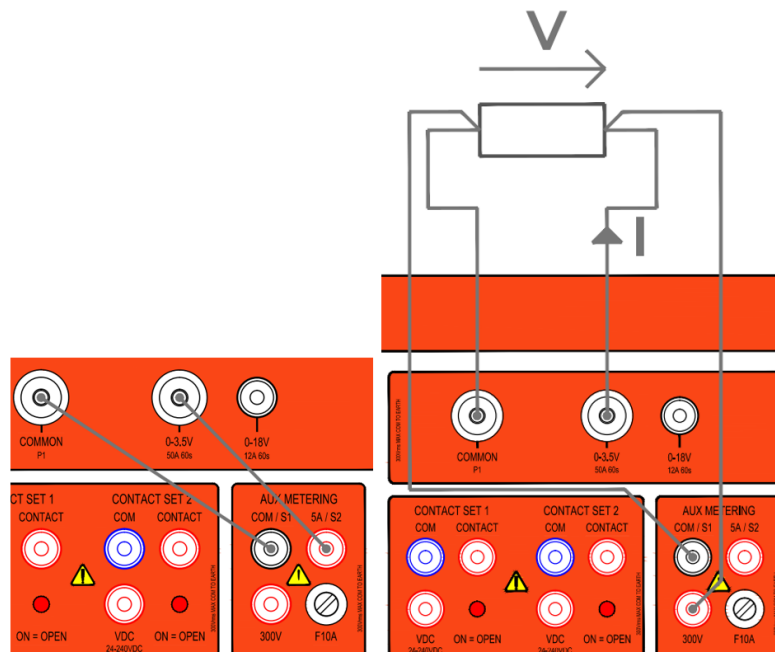

Figure 1.12 In phase for voltage and current

When measuring the phase angle between the output current and an external voltage, the 50ADM-P defines the voltage generated across a resistive load on any of the main outputs as in phase with the current. Connecting a resistor as shown in figure 2.6 will therefore result in a displayed phase of zero degrees.

1.3.6 Timing system

The 50ADM-P is fitted with an integrated timing system which is linked to the main output and two sets of contact inputs. The timer may also be used to time external events not linked to the output of the set. Two contact inputs are provided, each with a connection for volt-free contacts and DC voltage, and each auto-selects for normally open or normally closed contacts.

Timer information

Timer range	0-999.999s/9999.99s/99999.9s auto-ranging	
Resolution	1ms/10ms/100ms	
Accuracy	±0.01% rdg ±2d ±0.01% rdg ±4d	All modes except current operated Current operated mode
Contact o/c voltage	24V	
Contact s/c current	20mA	
Contact indication	LED on – contact open LED off – contact closed	

Timer Modes

Timer Mode	Timer Start Condition	Timer Stop Condition	Automatic output off	Example application
Off	-	-	-	Set current
Internal Start	Main output on	C1 change	When timer stops	IDMT relay
1 Contact using Contact 1	C1 1 st change	C1 2 nd change	C1 1 st change (timer start)	Auto-reclose relay
1 Contact using Contact 2	C2 1 st change	C2 2 nd change	C1 2 nd change (timer stop)	Drop-off timing
2 Contacts 1st change C1	C1 change	C2 change	C2 change (timer stop)	
2 Contacts 1st change C2	C2 change	C1 change	Output cycles on and off	Multiple auto re-close timing
Current Operated*	Current >20% of range	Current <10% of range	Current <10% Timer stop	Miniature circuit breakers
Pulse	Main output on	200ms	200ms	Set current for thermal devices
Aux ac	Aux ac on Aux ac off Var freq on Var freq off	C1 change	-	Frequency relays Under/over voltage relays

* results obtained with test currents below 20% of range will give a lower accuracy than specified.

The timer is automatically reset in every mode when the output is switched on. In each mode that the timer is active, the output of the unit must be switched on to arm the timer.

Each contact channel has a contact input for volt-free contacts and a Vdc input for dc voltages. The Vdc input may be used to trigger the timer from a dc voltage and will trigger from either the voltage switching from zero to 24-240Vdc or 24-240Vdc to zero. The voltage must be connected with positive to the red "Vdc" terminal and negative to the blue "com" terminal.

1.3.6.1 General Procedure for Timing Tests

To time the operation of any device a basic procedure needs to be followed to set the desired test current and to carry out the timing test.

- Connect the device under test to the output of the unit and to the contact inputs as required. For details of connection configurations, see the applications notes section.
- Set the timer to 'off' mode and the output control to zero. Switch on the output of the unit and increase the current or voltage to the desired level.
- Switch off the output of the unit and select the desired timer mode.
- Switch on the output of the unit. The timer will reset and then start when the start condition is met. Any change to the timer switch setting will be ignored once the output is switched on.

- The timer will stop when the stop condition is met.

1.3.6.2 *Timer mode: off*

In the 'off' mode, the timer has no effect on the operation of the set, and the timer does not run. This mode is used to set the required current through the test object before a timing test.

1.3.6.3 *Timer mode: internal start*

The internal start mode starts the timer when the main output is switched on and stops the timer on the first change of contact set 1. When the timer is stopped, the output of the unit is automatically switched off.

1.3.6.4 *Timer mode: 1 contact*

In single contact mode, the timer starts on the first change of state of contact set 1 after the output is switched on, and stops on the second change on contact set 1. Contact set 1 or contact set 2 can be used in 1 contact mode. If C1 (contact set 1) is used, the output is switched off when the timer is started, and if C2 (contact set 2) is used the output is switched off when the timer stops.

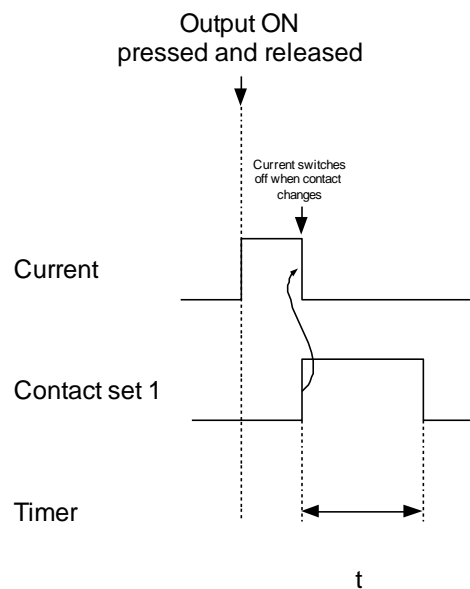

Figure 1.13 1 contact mode using contact set 1 (C1)

1 contact mode using C1 is used to time auto-reclose relays (connected to a breaker auxiliary contact). The time recorded is the time between the breaker opening and the first re-closing of the breaker.

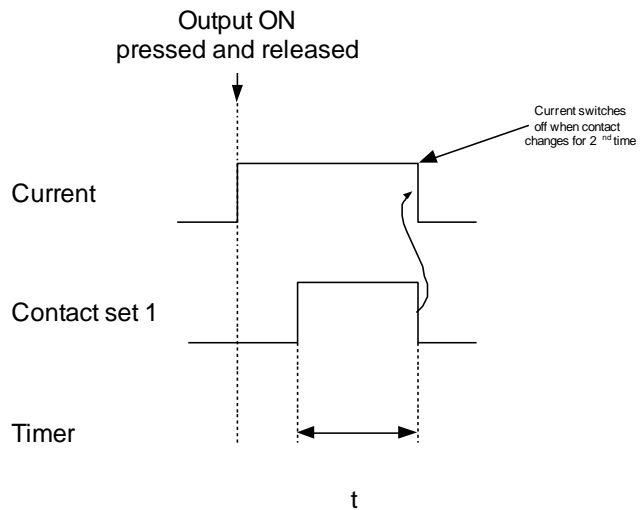

Figure 1.14 1 contact mode using contact set 2 (C2)

1 contact mode using C2 is suited to drop-off tests.

1.3.6.5 Timer mode: 2 contacts (contact 1 changes first)

Dual contact mode uses both contact set 1 and contact set 2. The timer starts on the first change of contact set 1 after the output is switched on and stops on the first change of contact set 2. The output of the unit is automatically switched off when the timer stops.

1.3.6.6 Timer mode: 2 contact MART (Multiple Auto-Reclose Timing)

This mode is used to time multiple re-close actions on an auto re-closing relay. 99 time results can be stored and logged to the USB memory key.

The auto re-close relay breaker trip contacts are connected to contact set C2 and the breaker close contact connected to contact set C1.

MART mode is triggered by contact set 2 changing state before contact set 1 in 2 contact mode.

- Start the test by pressing the ON pushbutton. The timer starts when the output is switched on.
- On the 1st change of C2 the timer result is stored as t0. The timer resets and restarts, and the output is switched off.
- On the 1st change of C1 the timer result is stored as t1. The output switches back on automatically, and the timer resets and restarts.
- On the 2nd change of C2 the timer result is stored as t2. The timer resets and restarts, and the output is switched off.
- On the 2nd change of C1 the timer result is stored as t3. The output switches back on automatically, and the timer resets and restarts.
- This cycle continues until the OFF pushbutton is pressed. The display is left showing the last timer value. If auto-store mode is selected, all the results for the test are written to the USB memory key. Up to 100 times can be recorded. After t99 is stored, the test ends, and the output switches off automatically.

At the end of the test the aux output ADJ knob is automatically put into timer result selection mode (both LEDs off). The ADJ knob scrolls through the timer results. The timer results are cleared when the output is switched on for another test.

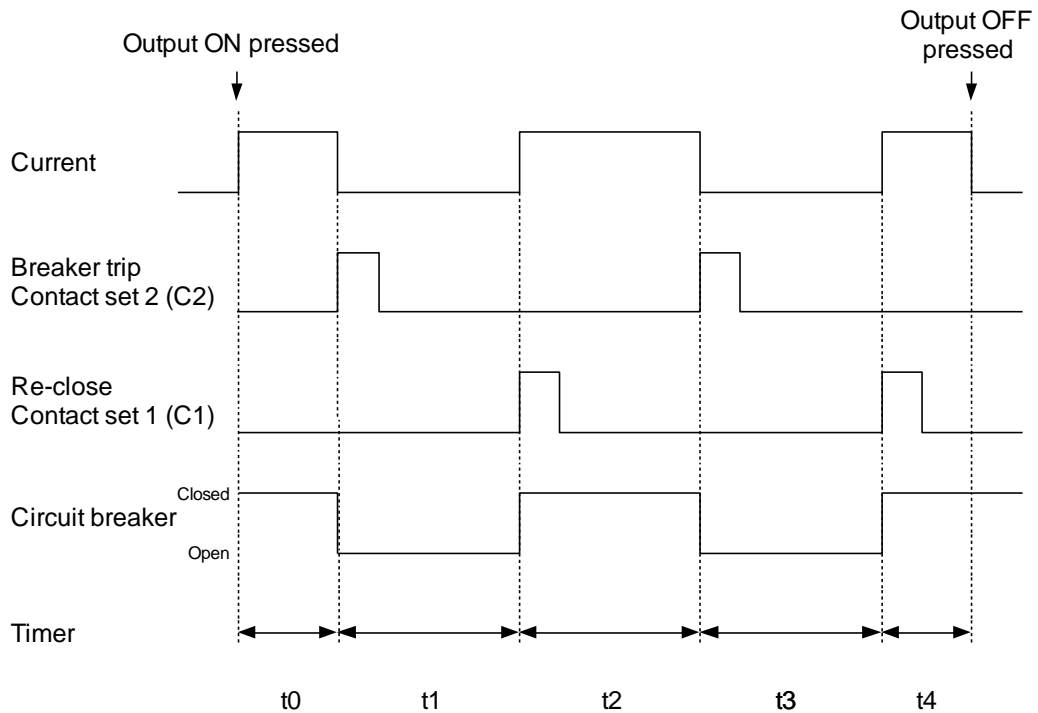
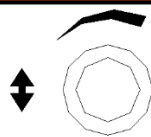
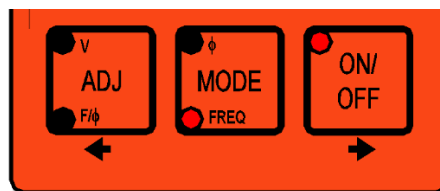

Figure 1.15 Multiple auto-reclose timing

To view the timing results, press the aux ac ADJ button until both the V and F/Φ LEDs are extinguished. The AUX AC ADJ control may then be used to scroll through the stored time values.



AUX AC ADJ

0.000A	t0	0.300s
0.0V	--.--Hz	--.--°

turn AUX AC ADJ clockwise

0.000A	t1	0.080s
0.0V	--.--Hz	--.--°

Figure 1.16 Displaying results for multiple auto-reclose timing

Note: To display re-close times, ensure that the auxiliary metering selector is set to any reading type other than harmonics (ac, dc, power, impedance or CT ratio).

1.3.6.7 *Timer mode: current operated*

Current operated mode is used to time devices that have contacts in series with the current sense element. This includes miniature circuit breakers and MCCBs.

The timer is started when the output current exceeds 20% of full scale of the selected metering range and stops when the current falls below this threshold.

1.3.6.8 *Timer mode: pulse*

Pulse mode is used to set the current in devices that are sensitive to heating due to the test current (thermal relays and circuit breakers and instantaneous trips). In this mode current is injected for 200ms when the ON switch is pressed. The current is captured and displayed.

1.3.6.9 *Timer mode: aux ac*

Aux ac timer mode starts the timer on the following events:

- Aux ac output switched on
- Aux ac output switched off
- Aux ac output switched from variable frequency to variable phase
- Aux ac output switched from variable to variable frequency

Note: The timer is reset and armed when the main output is switched on (the timer will not run unless the main output is switched on).

If the main output is switched on before the aux ac output, the timer will start when the auxiliary is switched on. If the auxiliary output is switched on before the main output, the timer will start when the auxiliary output is switched off or the mode is changed.

1.3.7 **Storage of results**

The 50ADM-P can store all displayed values to a CSV spreadsheet file whenever the timer stops, or the output is switched off. This is useful for recording all results, plotting relay curves and plotting transformer magnetisation curves.

Files are stored on the USB key in the folder \TRTEST. A folder is then created in this using the day's date, and results files are named with the time of the test.

A comment can be entered to be stored with the results using a USB keyboard.

The following values are stored:

- Time
- Date
- Main output current
- Timer result
- Auxiliary current/voltage input value
- Auxiliary current/voltage input phase angle
- Auxiliary current voltage input frequency
- Comment

Macros are provided with the unit to format results and plot graphs for IDMT overcurrent relays, CT mag curves and waveforms.

1.3.7.1 USB key

A standard USB flash memory key is used to store the results files. The unit has been tested with keys up to 8Gb in size.

Insert the USB key into the upper USB socket on the unit before starting to test. Most USB memory devices have an LED that indicates when the device is accessed. This will flash when a result is written.



Do not unplug the USB key whilst data is being written – data loss will result.

1.3.7.2 Setting the clock

The output of the unit must be switched off to set the clock.

- Set the STORE RESULT switch to SET CLOCK.

hh:mm:ss dd-mm-yy 10:13:24 15-12-08
--

- Use the ← and → keys to select which digit to change.
- Use the AUX AC ADJ control to change the selected digit.
- Use the red ON button to save the changes to the clock.
- Use the green OFF button to cancel setting the clock.
- Set the STORE RESULT switch to OFF.

1.3.7.3 Entering a comment

Each result is tagged with a comment when it is stored. The comment is entered by setting the store result control to “comment” and typing the comment using the optional USB keyboard.

The same comment is tagged to each result until the comment is updated, and the comment is erased when the unit is switched off.

Any USB keyboard can be used with the 50ADM-P.

The comment can be typed on the USB keyboard using the letters a-z, numbers 0-9 and punctuation marks. A maximum of 39 characters may be entered for the comment.

The following keys are also used:

Shift + a-z Enter capital letter.

←→ Move cursor left/right.

Ins Switch between overwrite and insert mode. By default, the unit will overwrite the character to the right of the cursor when a new character is typed. Switching to insert mode will shift characters of the right of the cursor right when a new character is typed.

Enter Accept the current comment.

Esc Lose the changes made to the comment since entering comment mode and revert to the last comment entered.

⇐ (backspace)	Delete the character to the left of the cursor.
Del	Delete the character under the cursor.
→ (cursor right)	Move cursor one character to the right.
← (cursor left)	Move cursor one character to the left.
Shift+→	Move cursor to end of comment.
Shift+←	Move cursor to start of comment.
End	Move cursor to end of comment.
Home	Move cursor to start of comment.

The following keys have no effect: caps lock, shift lock, alt, Windows key, tab, ↑, ↓, page up/down, F1-F12.

1.3.7.4 *Auto-store*

Set the STORE RESULTS switch to AUTO-STORE.

Set TIMER MODE to internal start, 1 contact, 2 contacts, current operated or aux ac.

A result record is added to the current result file whenever the timer stops (this includes when the output is switched off in internal start mode).

If results are to be stored not dependant on the timer, set the timer mode to internal start, and press the OFF button for the main output when a result is to be stored.

Results are not stored when the timer is set to OFF. This allows the output current to be set without storing any results to the output file.

The example below shows data stored when testing a relay.

```
"50ADM-P  ", "V0.12", "C00", "P1", "A1"
"Time", "Date", "Main A", "Timer", "Aux A", "Aux V", "Phase", "Freq Hz", "Aux Range", "Comment"
"11:18:40", "27/11/20", "2.38", "7.961", "0.000", "0.0", "0.0", "0.00", "6", "CDG11 relay"
"11:18:49", "27/11/20", "3.73", "5.252", "0.000", "0.0", "0.0", "0.00", "6", "CDG11 relay"
```

1.3.7.5 *Waveform storage*

Waveform storage mode allows the main output current and auxiliary input waveform to the USB memory key as a CSV file.

Set the STORE RESULTS switch to WAVEFORM.

Set TIMER MODE to internal start, 1 contact, 2 contacts or current operated.

The waveform is stored to the memory key whenever the timer stops, or the output is switched off. It takes several seconds to write the waveform data to the memory key. Please be patient while the unit finishes writing the data.

A spreadsheet program (e.g. Microsoft Excel or OpenOffice Calc) can be used to show the waveform graphically. A macro is available for Excel to automatically format and plot waveform data.

1.3.7.6 File formats

Results file format

The results file is in CSV (comma separated value) format. The first line of the file details unit type, software version and configuration information. The second line specifies column headings for the data, and the third line onwards is data.

```
"50ADM-P", "V0.12", "C00", "P1", "A1"  
"Time", "Date", "Main A", "Timer", "Aux A", "Aux V", "Phase", "Freq Hz", "Aux Range", "Comment"  
"11:18:40", "27/11/20", "0.00", "0.000", "0.000", "0.0", "0.0", "0.00", "6", "Comment - up to 39 chars"
```

Double-clicking on a results file in MS Windows on a PC with a spreadsheet installed will open the file. Excel macros are provided on the optional USB memory key and from www.trtest.com.

To use the macros, open the "200ADM-P tools" Excel spreadsheet before opening the results CSV file. This will install a toolbar in Excel with buttons for formatting overcurrent and waveform results files. Refer to the instructions in the 200ADM-P tools spreadsheet for further details.

Waveform file format

The waveform file is in CSV (comma separated value) format.

The first line lists the time, date, and time between samples in ms (0.06=60us). The second line specifies column headings, and subsequent lines list one sample value for main output current in A and one sample value for the auxiliary input in A or V. 1024 samples are stored at 60us intervals for a total sampling time of 61.44ms.

```
"11:57:34", "27/11/20", "", "", "", "Sample Time (ms)", "0.06"  
"Main", "Aux. I"  
"0.000", "0.000"  
"0.000", "0.000"  
"0.000", "0.000"  
"0.000", "0.000"  
"0.000", "0.000"  
:  
:  
:  
"0.000", "0.000"
```

Double-clicking on a results file in MS Windows on a PC with a spreadsheet installed will open the file. Excel macros are available from T&R Test for formatting the results.

1.3.7.7 Viewing results

The VIEW RESULTS setting allows the results from the current day to be displayed.

Ensure the main output is off. Set the STORE RESULTS switch to VIEW. The files to view can be scrolled through using AUX AC ADJ and the file to view opened using →. The results in the file can then be stepped through using AUX AC ADJ.

Press OFF to delete the current result. Changes are not saved after deleting a result until the → key is pressed.

2. OPERATION

This chapter describes how to use the different outputs and timing modes on the 50ADM-P. Details of testing specific relay types are given in the application notes section of this manual.

2.1 Current injection – 1 current

2.1.1 AC current injection without timing

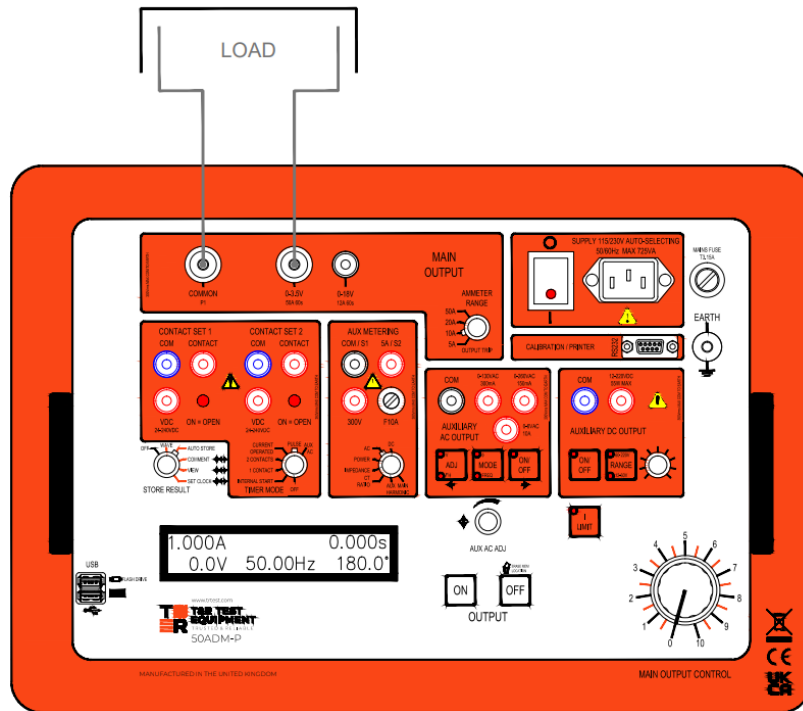

Figure 2.1 Main output ac current

Ammeter range	Select as required	Main output on/off	On
Store result	n/a	I limit	On for current <10A
Timer mode	Off	Aux ac output adj	n/a
Aux metering	n/a	Aux ac output mode	n/a
Aux dc voltage	If required by relay	Aux ac output on/off	n/a

The contacts of the device under test do not need to be connected for current injection without timing, but it can be useful to show the contact state for pick-up and drop-off (drop-out) tests.

- Set the output control to zero.
- If testing at <10A, switch on I limit mode. For the finest current control use the 18V 12A output.
- Switch the output on and increase the test current to the desired level (for pick-up tests increase the current slowly until the relay picks up).
- Switch the output off after testing.

2.1.2 AC current injection with timing

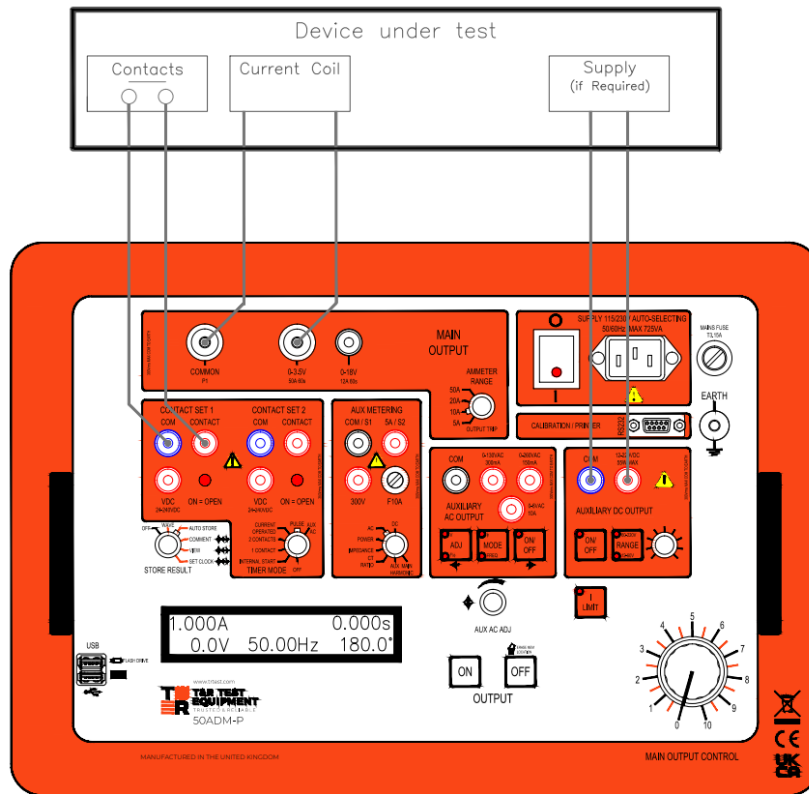

Figure 2.2 Main output ac current with timing

Ammeter range	Select as required	Main output on/off	On
Store result	n/a	I limit	On for current <10A
Timer mode	Internal start	Aux ac output adj	n/a
Aux metering	n/a	Aux ac output mode	n/a
Aux dc voltage	If required by relay	Aux ac output on/off	n/a

- Set the output control to zero.
- If testing at <10A, switch on I limit mode.
- Switch the output on and increase the test current to the desired level.
- Switch the output off.
- Switch the TIMER MODE to INTERNAL START.
- Switch the output on. Current injection will commence, and the timer will start. The timer will stop when contact set 1 changes state.

2.1.3 AC current injection with result storage

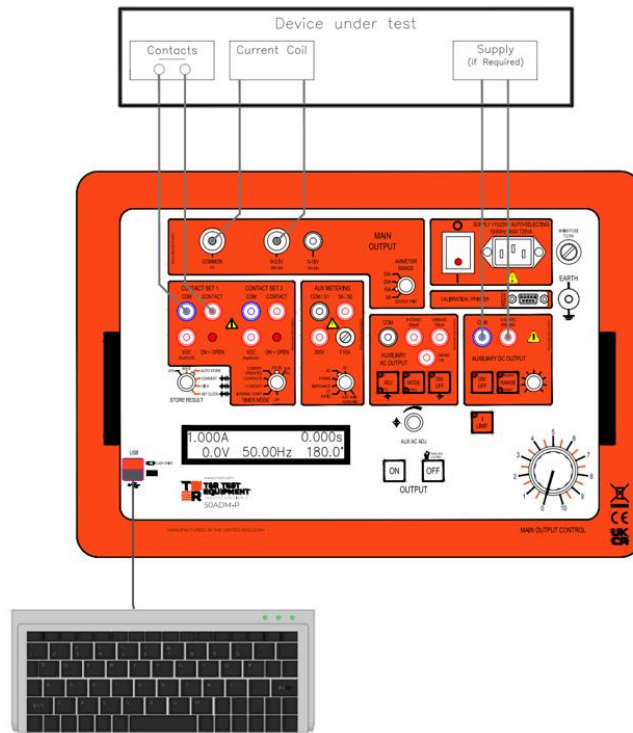

Figure 2.3 Current injection with result storage

Ammeter range	Select as required	Main output on/off	On
Store result	Auto-store	I limit	On for current <10A
Timer mode	Internal start	Aux ac output adj	n/a
Aux metering	n/a	Aux ac output mode	n/a
Aux dc voltage	Off	Aux ac output on/off	n/a

- Ensure that a USB memory key is plugged into the upper USB port and a USB keyboard is plugged into the lower USB port.
- Set STORE RESULT to COMMENT. If no keyboard is plugged in, the display will show 'no keyboard present'. Enter your comment for the test using the keyboard (up to 39 characters). This comment will be appended to all results in this session until you change it or turn off the unit.
- Set STORE RESULT to AUTO STORE.
- Set the output control to zero.
- If testing at <10A, switch on I limit mode.
- Switch TIMER MODE to OFF.
- Switch the output on and increase the test current to the desired level.
- Switch the output off.
- Switch the TIMER MODE to INTERNAL START.
- Switch the output on. Current injection will commence, the timer will start. The timer will stop when contact set 1 changes state. The test results will be recoded to the memory key.
- Repeat the last 5 stages for other points on the relay curve.

2.2 Current injection – 2 currents

2.2.1 AC current injection with timing

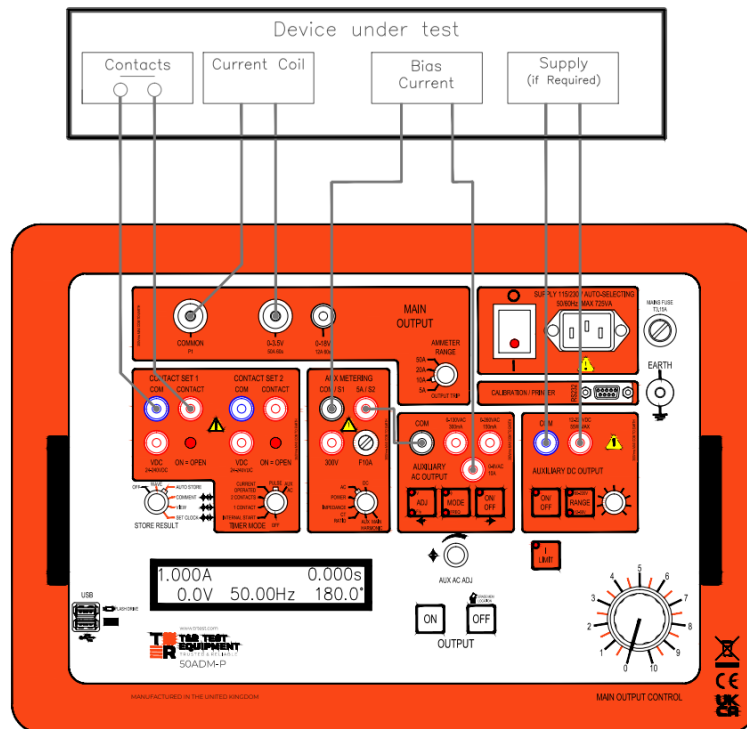

Figure 2.4 2 ac currents

Ammeter range	Select as required	Main output on/off	On
Store result	n/a	I limit	Off
Timer mode	Internal start/Aux ac	Aux ac output adj	V
Aux metering	RMS	Aux ac output mode	Φ
Aux dc voltage	If required by relay	Aux ac output on/off	On

Two currents may be supplied simultaneously from the unit. The second current is supplied from the auxiliary ac output.

Timing is as for a single current, although if the timer is to be started from the second current switching on use aux ac timer mode.

2.3 Voltage supply – 1 voltage

2.3.1 AC voltage output without timing

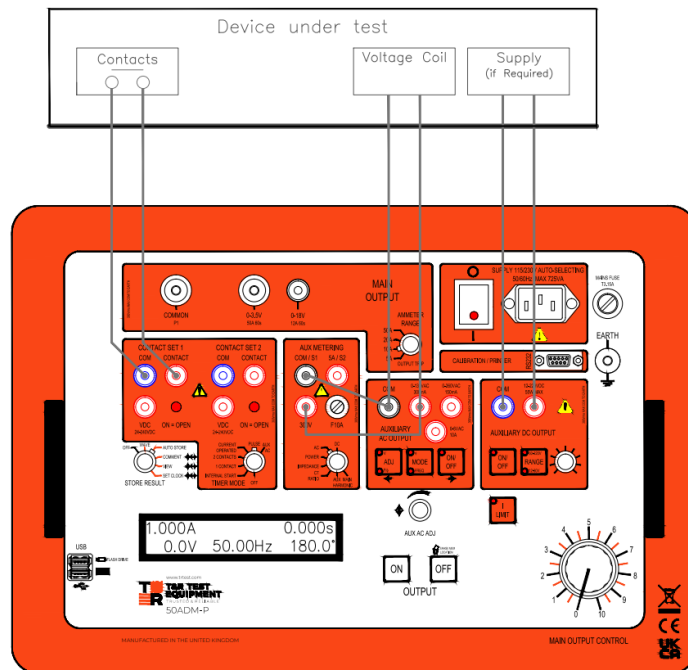

Figure 2.5 Main output ac voltage

Ammeter range	n/a	Main output on/off	On
Store result	n/a	I limit	Off
Timer mode	Internal start/Aux ac	Aux ac output adj	V
Aux metering	RMS	Aux ac output mode	Φ or f
Aux dc voltage	If required by relay	Aux ac output on/off	On

- Connect the test object to the auxiliary ac output.
- Switch the auxiliary ac output on and increase the test voltage to the desired level.
- If a different frequency is required, press ADJ to select V/Φ and press MODE to select FREQ. The frequency can then be adjusted using AUX AC ADJ.
- Switch the output off after testing.

2.3.2 AC voltage step with timing

A voltage step can be created by connecting the main output in series with the auxiliary ac output. This can be used to time under and over-voltage relays.

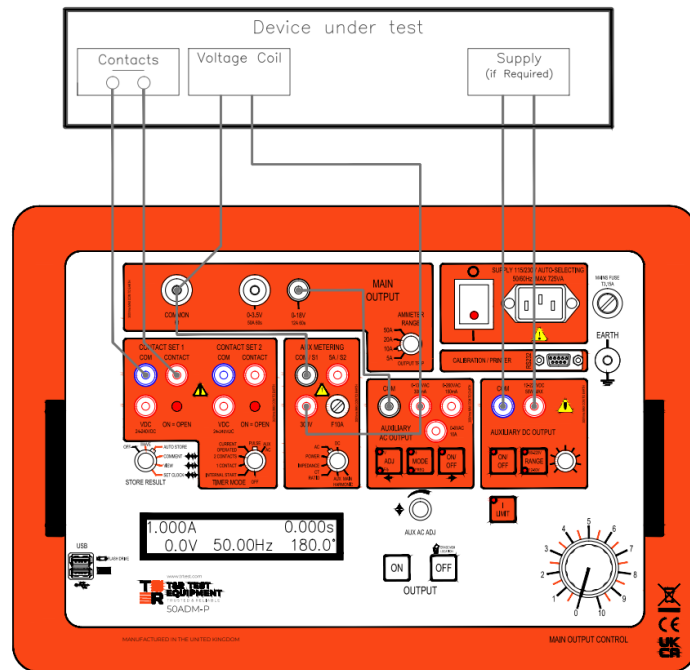

Figure 2.6 Voltage step

Ammeter range	n/a	Main output on/off	On
Store result	n/a	I limit	Off
Timer mode	Aux ac	Aux ac output adj	V
Aux metering	RMS	Aux ac output mode	φ
Aux dc voltage	If required by relay	Aux ac output on/off	On

Step up

- Set the output control to zero.
- Switch the main output on and increase the voltage to the relay nominal voltage, V_n .
- Switch the auxiliary ac output on, and increase the output voltage until the total voltage is at the required level to trip the relay.
- Switch both outputs off.
- Switch the main output on and wait for the relay to settle.
- Switch the auxiliary ac output on. The timer will start when the voltage step is applied, and stop when contact set 1 changes state.
- Switch the output off after testing.

Step down

- Set the output control to zero.
- Switch the main output on and increase to the voltage required at the end of the step.
- Switch the auxiliary ac output on, and increase the total output voltage to the relay nominal voltage, V_n .

- Switch the main output off and on again (leave the aux ac on). This resets the timer.
- Switch the auxiliary ac output off. The timer will start when the voltage step is applied, and stop when contact set 1 changes state.
- Switch the output off after testing.

2.4 Voltage supply – 2 voltages

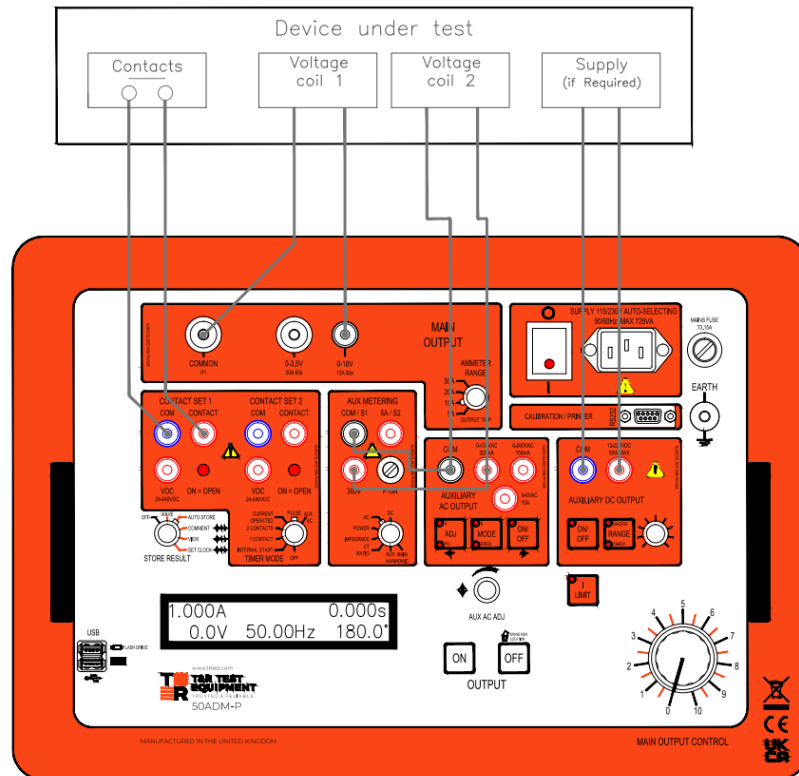

Figure 2.8 Two ac voltages

Ammeter range	n/a	Main output on/off	On
Store result	n/a	I limit	Off
Timer mode	Internal start/aux ac	Aux ac output adj	V
Aux metering	AC	Aux ac output mode	Φ
Aux dc voltage	If required by relay	Aux ac output on/off	On

When supplying two ac voltages to a test object the auxiliary metering input should be used to meter each in turn.

2.5 Current injection with phase shift voltage – 1 current & 1 voltage

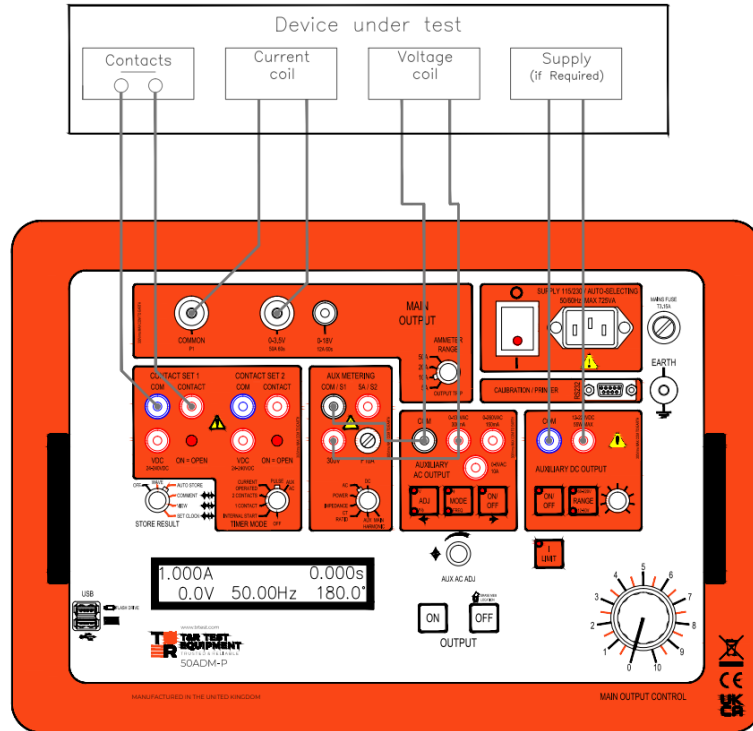

Figure 2.9 Current and voltage

Ammeter range	As required	Main output on/off	On
Store result	n/a	I limit	Off
Timer mode	Internal start	Aux ac output adj	V
Aux metering	AC	Aux ac output mode	Φ
Aux dc voltage	If required by relay	Aux ac output on/off	On

3 APPLICATIONS

3.1 Over-current and earth fault relays

3.1.1 Pick-up and drop-off test

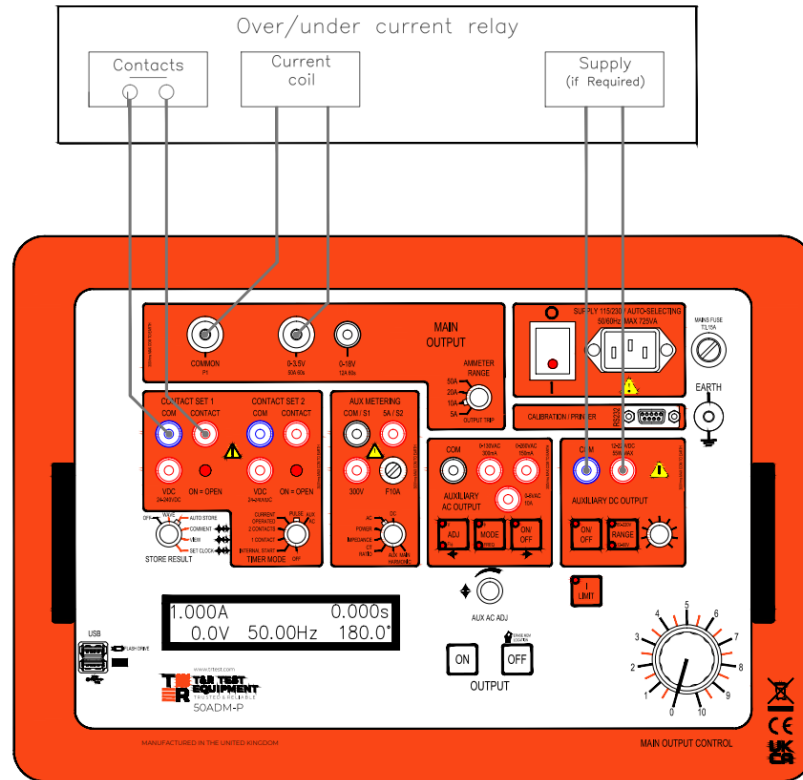

Figure 3.1 Connections for current pick-up/drop-off test (no storage)

Ammeter range	Select as required	Main output on/off	On
Store result	Off	I limit	On for current <10A
Timer mode	Off	Aux ac output adj	n/a
Aux metering	n/a	Aux ac output mode	n/a
Aux dc voltage	As required for relay	Aux ac output on/off	n/a

Procedure

1. Set main current output control to zero (anti-clockwise).
2. Switch on main current output.
3. Increase the main output current until the relay trips. The relay contact state is shown on the contact 1 LED. Record the current at which the relay tripped.
4. To find the drop-off point, reduce the current until the relay contacts reset. Record the drop-off current.

3.1.2 Timing test

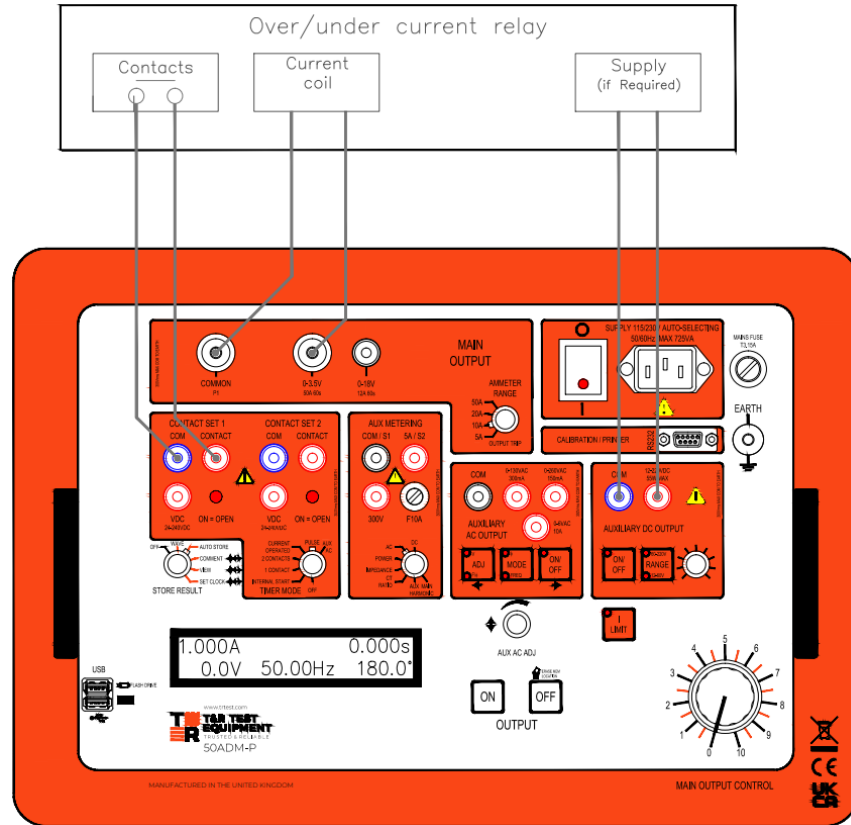

Figure 3.2 Connections for over-current timing

Ammeter range	Select as required	Main output on/off	On
Store result	Off	I limit	On for current <10A
Timer mode	Internal start	Aux ac output adj	n/a
Aux metering	n/a	Aux ac output mode	n/a
Aux dc voltage	As required for relay	Aux ac output on/off	n/a

Procedure

1. Set main current output control to zero (anti-clockwise).
2. Set TIMER MODE to OFF.
3. Switch on main current output.
4. Set the required test current and switch the output off.
5. Set TIMER MODE to INTERNAL START.
6. Switch on main output current. The output will come on and the timer will start.
7. When the relay trips the timer will stop and the output will switch off.
8. Repeat steps 2 to 7 for other test currents as required.

3.1.3 Timing test with recording of results

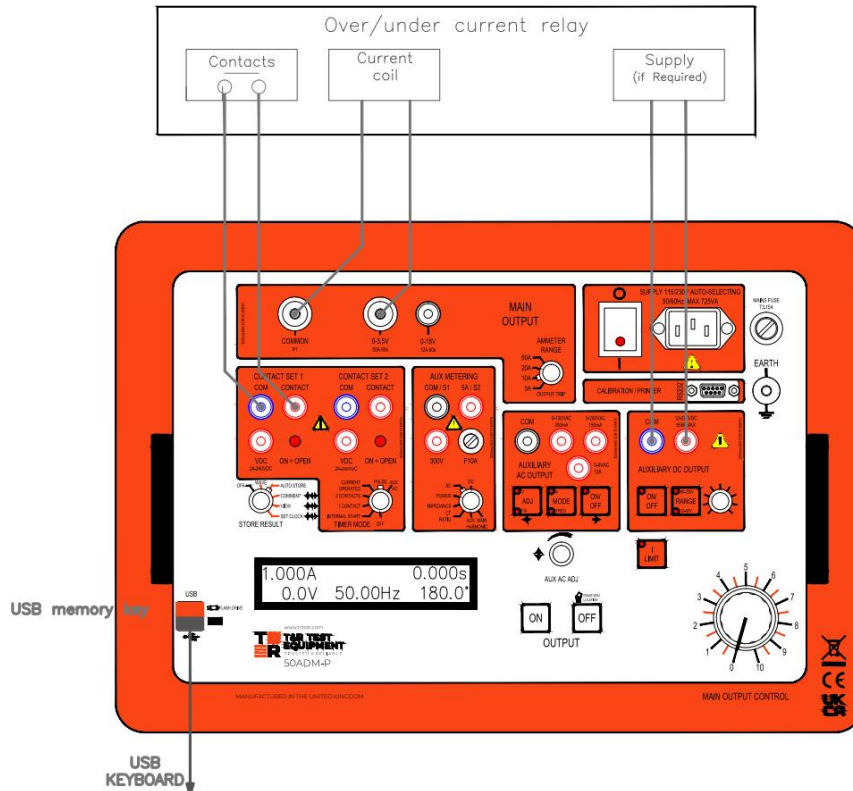

Figure 3.3 Connections for overcurrent timing

Ammeter range	Select as required	Main output on/off	On
Store result	Auto-store	I limit	On for current <10A
Timer mode	Internal start	Aux ac output adj	n/a
Aux metering	n/a	Aux ac output mode	n/a
Aux dc voltage	As required for relay	Aux ac output on/off	n/a

Procedure

1. Ensure USB memory key is inserted in USB socket if result storage is required. Enter a comment for the test using the USB keyboard (Set STORE RESULT to COMMENT).
2. Set STORE RESULT to AUTO-STORE.
3. Set main current output control to zero (anti-clockwise).
4. Set TIMER MODE to OFF.
5. Switch on main current output.
6. Set the required test current and switch the output off.
7. Set TIMER MODE to INTERNAL START.
8. Switch on main output current. The output will come on and the timer will start.
9. When the relay trips the timer will stop and the output will switch off.
10. Repeat steps 4 to 10 for other test currents as required.

3.1.3 Drop-off test with timing

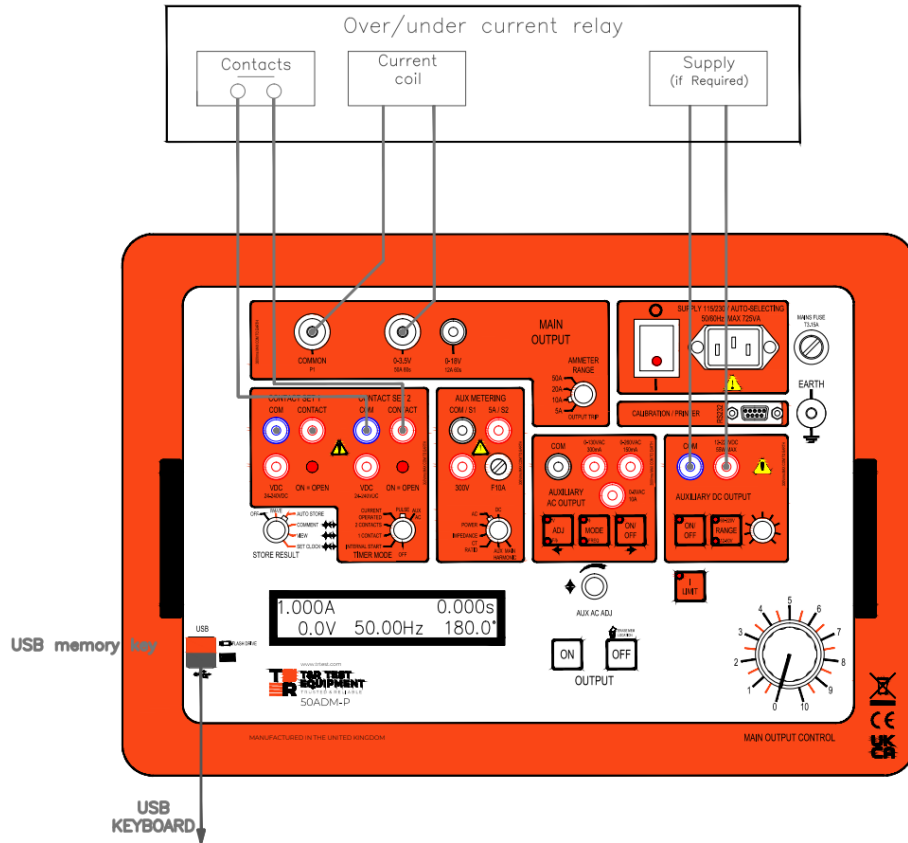

Figure 3.4 Connections for current drop-off test (with storage of result)

Ammeter range	Select as required	Main output on/off	On
Store result	Auto-store	I limit	On for current <10A
Timer mode	Single contact Use contact set 2	Aux ac output adj	n/a
Aux metering	n/a	Aux ac output mode	n/a
Aux dc voltage	As required for relay	Aux ac output on/off	n/a

Procedure

Note: Contacts connected to contact set 2 (see section 1.3.6 for details of contact modes). If connected to contact set 1 the output will switch off after the first contact set change.

1. Set main current output control to zero (anti-clockwise).
2. Switch on main current output.
3. Increase the main output current until the relay picks up.
4. Switch off the output using the OFF switch.
5. The output will switch off and the timer will start. The timer will stop when the relay drops out.

3.2 Under-current relays

3.2.1 Pick-up and drop-off test

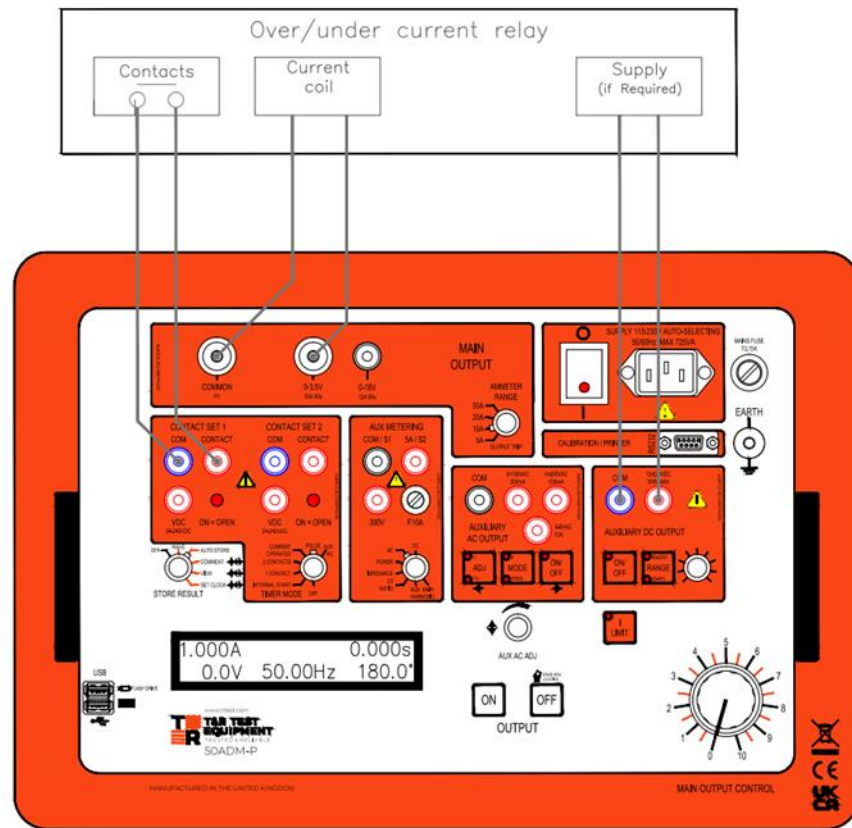

Figure 3.5 Connections for current pick-up/drop-off test (no storage)

Ammeter range	Select as required	Main output on/off	On
Store result	Off	I limit	On for current <10A
Timer mode	Off	Aux ac output adj	n/a
Aux metering	n/a	Aux ac output mode	n/a
Aux dc voltage	As required for relay	Aux ac output on/off	n/a

Procedure

1. Set main current output control to zero (anti-clockwise).
2. Switch on main current output.
3. Increase the main output current until the current is higher than the relay setting. The relay should now reset.
4. Decrease the current until the relay trips. This is the pick-up value.
5. Increase the current until the relay resets. This is the drop-off value.

3.3 Under and over-voltage relays

3.3.1 Pick-up and drop-off test

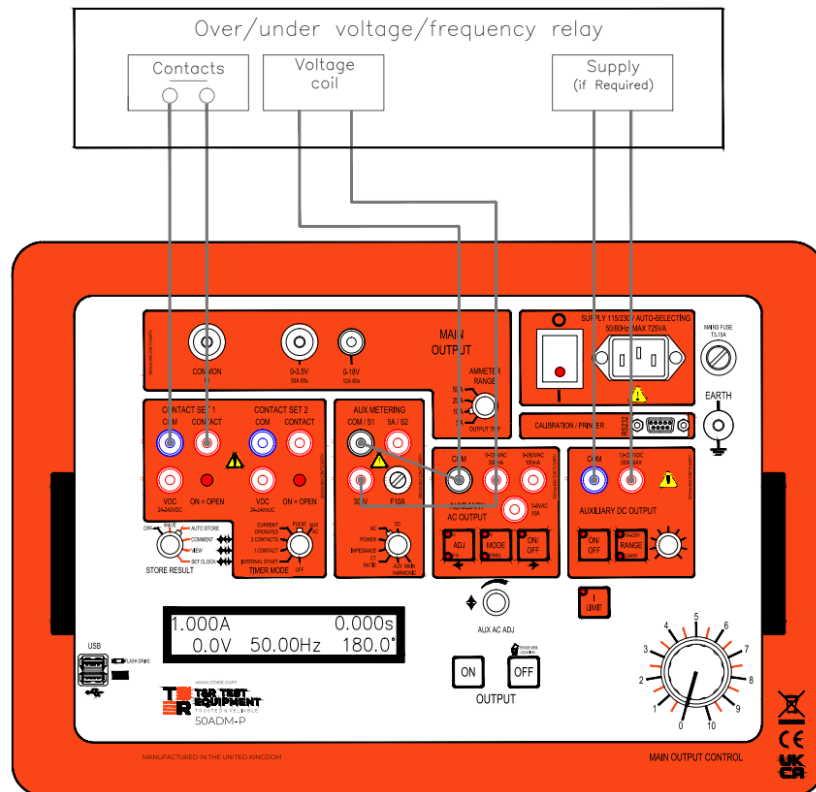

Figure 3.6 Connections for pick-up/drop-off test

Ammeter range	n/a	Main output on/off	On
Store result	Off	I limit	Off
Timer mode	Off	Aux ac output adj	n/a
Aux metering	AC	Aux ac output mode	n/a
Aux dc voltage	As required for relay	Aux ac output on/off	n/a

Procedure

1. Switch on auxiliary ac output.
2. Increase the auxiliary ac voltage until the relay trips. The voltage is measured using the auxiliary metering and shown on the bottom line of the display. The relay contact state is shown on the contact 1 LED. Record the voltage at which the relay tripped.
3. To find the drop-off point, reduce the voltage until the relay contacts reset. Record the drop-off voltage.
4. For an under voltage relay start above the trip voltage and reduce to find the pick-up point, then increase to find the drop-off voltage.

3.3.2 Timing of over-voltage relays

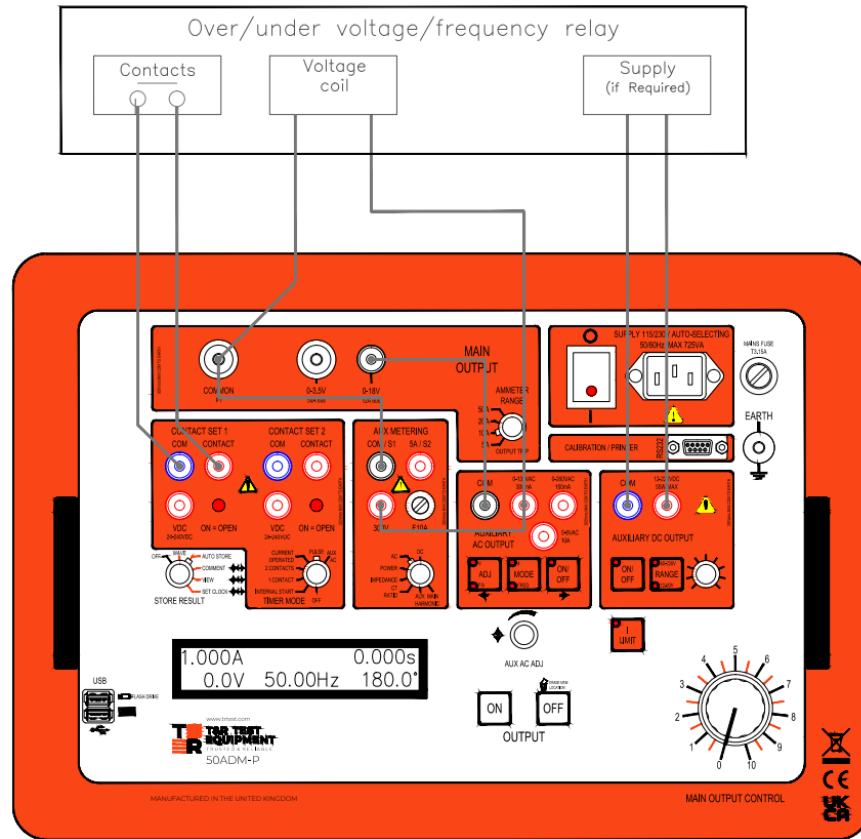

Figure 3.7 Over-voltage with timing

Ammeter range	n/a	Main output on/off	On
Store result	n/a	I limit	Off
Timer mode	Aux ac	Aux ac output adj	V
Aux metering	RMS	Aux ac output mode	Φ
Aux dc voltage	If required by relay	Aux ac output on/off	On

Over-voltage pickup time

1. Set the output control to zero.
2. Switch the main output on and increase the voltage to the relay nominal voltage, V_n .
3. Switch the auxiliary ac output on, and increase the output voltage until the total voltage is at the required level to trip the relay.
4. Switch both outputs off.
5. Switch the main output on and wait for the relay to settle.
6. Switch the auxiliary ac output on. The timer will start when the voltage step is applied, and stop when contact set 1 changes state.
7. Switch the output off after testing.

Over-voltage dropout time

1. Leave the controls set from the pickup test.
2. Switch the auxiliary ac output on.

3. Switch the main output on. This arms the timer.
4. Switch the auxiliary ac output off. The timer will start when the aux ac switches off, and stop when contact set 1 changes state.
5. Switch the outputs off after testing.

3.3.3 Timing of under-voltage relays

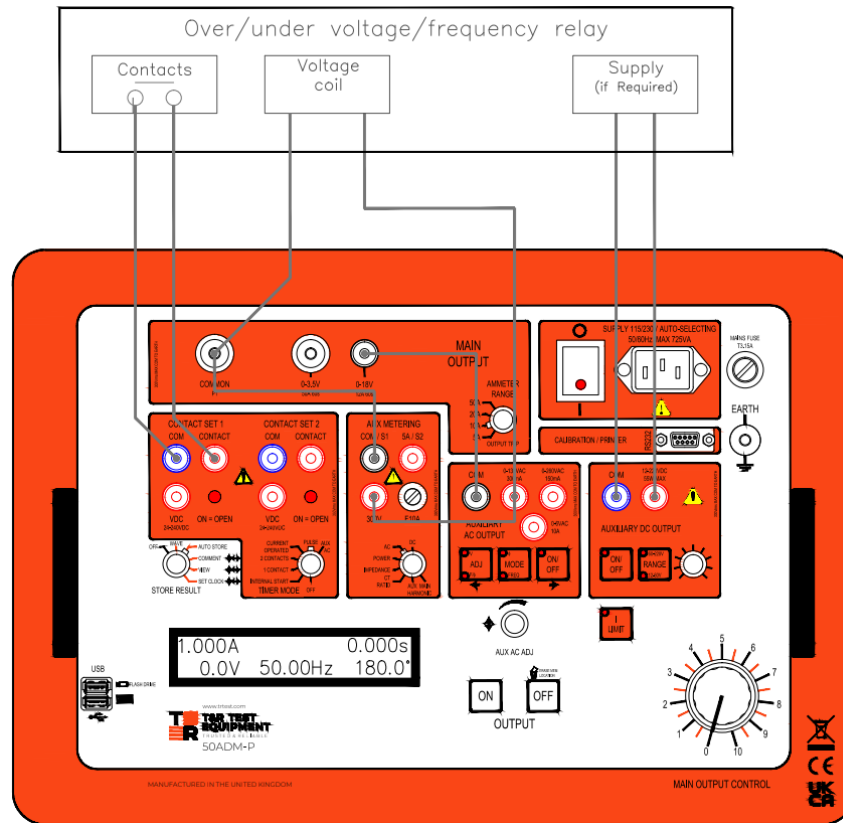

Figure 3.8 Under-voltage with timing

Ammeter range	n/a	Main output on/off	On
Store result	n/a	I limit	Off
Timer mode	Aux ac	Aux ac output adj	V
Aux metering	RMS	Aux ac output mode	Φ
Aux dc voltage	If required by relay	Aux ac output on/off	On

Under-voltage pickup time

1. Set the output control to zero.
2. Switch the main output on and increase the voltage to a voltage below V_n that will trip the relay.
3. Switch the auxiliary ac output on, and increase the output voltage until the total voltage is V_n .
4. Switch both outputs off.
5. Switch the auxiliary ac output on.
6. Switch the main output on. This arms the timer.

7. Switch the auxiliary ac output off. The timer will start when the aux ac switches off, and stop when contact set 1 changes state.
8. Switch the outputs off after testing.

Under-voltage dropout time

1. Leave the controls set from the pickup test.
2. Switch the main output on.
3. Switch the auxiliary ac output on. The timer will start and then stop when the relay drops out.

3.4 Under and over frequency relays

3.4.1 Pick-up and drop-off test

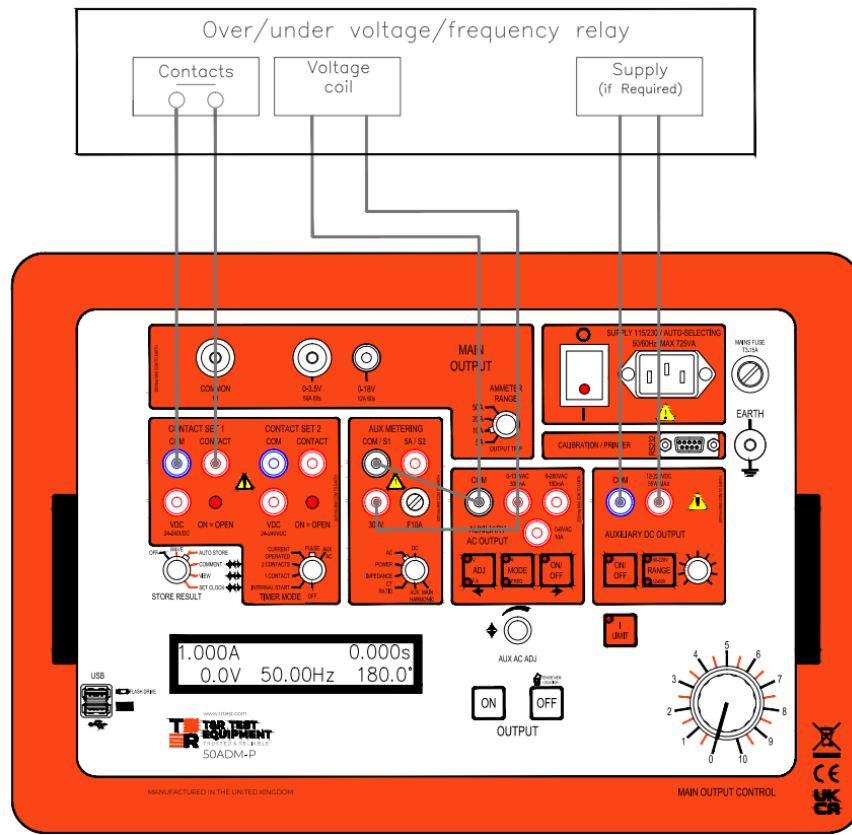

Figure 3.9 Connections for pick-up/drop-off test

Ammeter range	n/a	Main output on/off	Off
Store result	Off	I limit	n/a
Timer mode	Off	Aux ac output adj	V then F/Φ
Aux metering	AC	Aux ac output mode	f
Aux dc voltage	As required for relay	Aux ac output on/off	On

1. Switch on the aux ac output. Select V using adj button.
2. Increase the voltage using the AUX AC ADJ control to the relay operating voltage.
3. Press ADJ to select F/Φ, and press MODE button to select MAIN FREQ.
4. For an over-frequency relay increase the frequency using the AUX AC ADJ control until the relay trips. The relay contact state is shown on the contact 1 LED. Record the pick-up frequency.
5. Reduce the frequency until the relay resets. Record the drop-off frequency.
6. For an under-frequency relay decrease the frequency using the AUX AC ADJ control until the relay trips. The relay contact state is shown on the contact 1 LED. Record the pick-up frequency.
7. Increase the frequency until the relay resets. Record the drop-off frequency.

3.4.2 Timing test

Ammeter range	n/a	Main output on/off	On (to arm timer)
Store result	Off	I limit	n/a
Timer mode	AUX AC	Aux ac output adj	V then F/ Φ
Aux metering	AC	Aux ac output mode	f
Aux dc voltage	As required for relay	Aux ac output on/off	On

The output frequency of the auxiliary output can be switched between supply frequency (Φ) and variable frequency (FREQ) using the MODE button. This procedure uses this to switch between two frequencies to time the operation of over or under frequency relays.

1. Connections as for pick-up/drop-off test as figure 3.9.
2. Switch on the aux ac output. Select V using ADJ button.
3. Increase the voltage using the AUX AC ADJ control to the relay operating voltage.
4. Press ADJ to select F/ Φ , and press MODE button to select FREQ.
5. Increase the frequency (for an over-frequency relay) using the AUX AC ADJ control to a value that will definitely trip the relay – you will see the relay trip as the frequency is increased. For an under-frequency relay set a frequency lower than the supply frequency.
6. Press MODE to select Φ . This selects supply frequency.
7. Reset the relay.
8. Ensure that TIMER MODE is set to AUX AC. Switch the main output ON to arm the timer.
9. Press MODE to select FREQ. The frequency is set to the frequency set in step 4, and the timer starts.
10. The timer stops when contact set 1 changes.
11. Switch the outputs off after testing.

3.5 Auto reset/re-closing devices

Auto re-closing devices require that the timer is started when power is removed from the device, and the timer stops when the contacts change state. Using the 50ADM-P, it is possible to time either the first re-close operation only or a complete series of re-closing actions.

3.5.1 Timing a single re-close action with circuit breaker

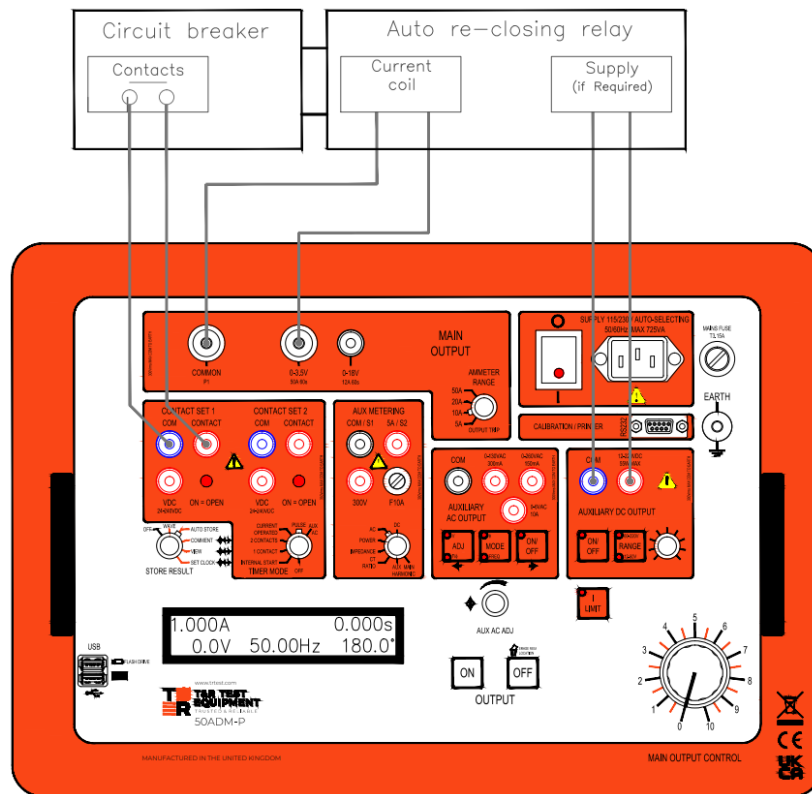

Figure 3.10 Connections for testing auto-reclose relay and circuit breaker

Ammeter range	Select as required	Main output on/off	On
Store result	Off	I limit	On for I<10A
Timer mode	1 Contact Contact set 1	Aux ac output adj Aux ac output mode Aux ac output on/off	Both LEDs off n/a n/a
Aux metering	Dc , ac, power, impedance, CT ratio. NOT harmonics.		
Aux dc voltage	As required for relay		

Procedure to time re-closing devices (single re-close with circuit breaker connected)

1. Set main output control to zero.
2. Set TIMER MODE to OFF.
3. Switch on main output and increase to desired test current.
4. Switch off main output and set TIMER MODE to 1 CONTACT.
5. Switch on main output by pressing the ON pushbutton briefly. The relay trips, starts the timer and switches off the output. The unit times between the first contact change when the current is switched off and the second contact change.

3.5.2 Procedure to time auto re-closing relay

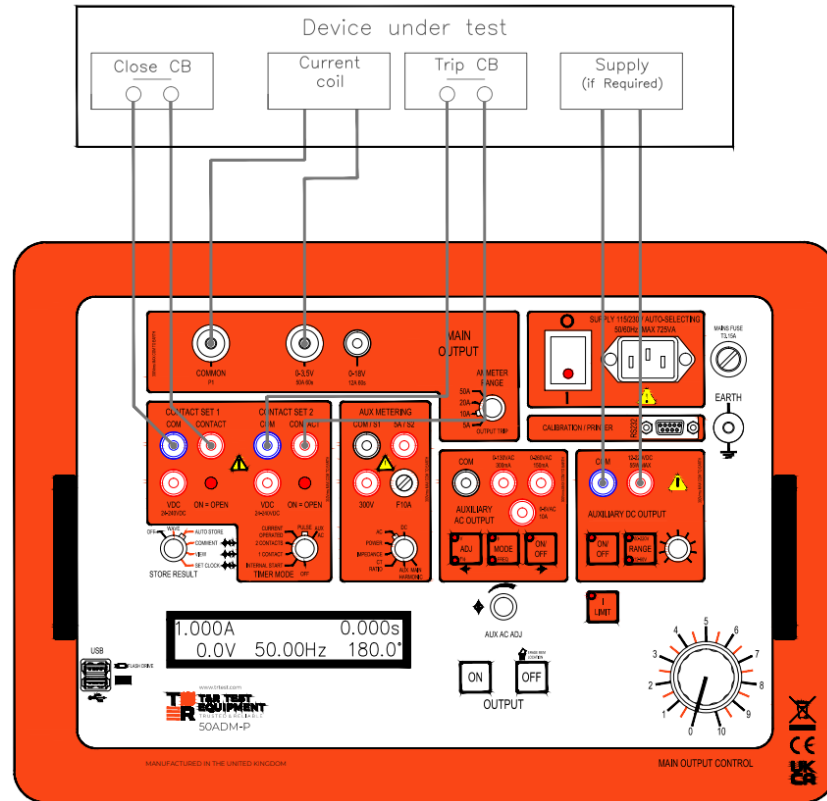

Figure 3.11 Connections for testing auto-reclose relay

Ammeter range	Select as required	Main output on/off	On
Store result	Off	I limit	On for I<10A
Timer mode	2 Contact	Aux ac output adj	Both LEDs off
Aux metering	Dc , ac, power, impedance, CT ratio. NOT harmonics.	Aux ac output mode	n/a
Aux dc voltage	As required for relay	Aux ac output on/off	n/a

Procedure to time auto re-closing relay

1. Set main output control to zero.
2. Set TIMER MODE to OFF.
3. Switch on main output and increase to desired test current.
4. Switch off main output and set TIMER MODE to 2 CONTACTS.
5. Ensure that the breaker close signal from the relay is connected to contact set 1 and the breaker trip contact is connected to contact set 2.
6. Start the test by pressing the ON pushbutton. The timer starts when the output is switched on.
7. On the 1st change of C2 (breaker trip contact) the timer result is stored as t0 (time to trip from inception of fault). The timer resets and restarts, and the output is switched off.

8. On the 1st change of C1 (breaker close contact) the timer result is stored as t1 (first re-close time). The output switches back on automatically, and the timer resets and restarts.
9. On the 2nd change of C2 (breaker trip) the timer result is stored as t2 (second trip time). The timer resets and restarts, and the output is switched off.
10. On the 2nd change of C1 (breaker close) the timer result is stored as t3 (second re-close time). The output switches back on automatically, and the timer resets and restarts.
11. This cycle continues until the OFF pushbutton is pressed. The display is left showing the last timer value. If auto-store mode is selected, all of the results for the test are written to the USB memory key. Up to 100 times can be recorded. After t99 is stored the test ends and the output switches off automatically.

At the end of the test the aux output ADJ knob is automatically put into timer result selection mode (both LEDs off). The ADJ knob scrolls through the timer results. The timer results are cleared when the output is switched on for another test.

3.6 Timing circuit breakers

Testing CBEs (circuit breakers for equipment) MCBs (miniature circuit breakers) and other devices with no auxiliary contacts is possible using the current operated timer mode on the 50ADM-P. This mode starts the timer when the output current exceeds 20% of the selected current range, and stops the timer when the current falls below 20% of range.

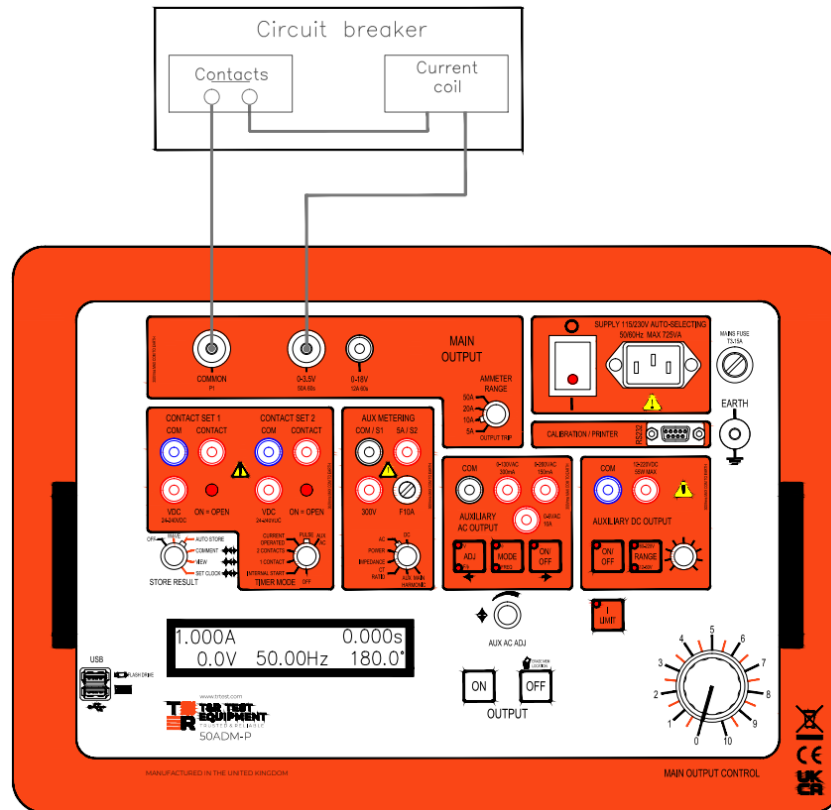

Figure 3.12 Connections for testing circuit breakers

Ammeter range	Select as required	Main output on/off	On
Store result	Off	I limit	Off
Timer mode	Current operated	Aux ac output adj	n/a
Aux metering	n/a	Aux ac output mode	n/a
Aux dc voltage	n/a	Aux ac output on/off	n/a

1. Set the current metering range so that the device trip current is >20% of the selected metering range.
2. Set main output to zero.
3. Set TIMER MODE to off
4. Switch the output on and increase the current to the desired test current. For thermal devices or devices with short trip times pulse mode can be used to set the current – current is injected for 200ms each time ON is pressed. Increase the current in stages until the desired current is reached.
5. Set TIMER MODE to CURRENT OPERATED.
6. Switch the output on. The timer will stop when the circuit breaker opens.

3.7 Directional overcurrent/earth fault relays

Testing a single phase directional relay requires one current and a phase-shifting voltage.

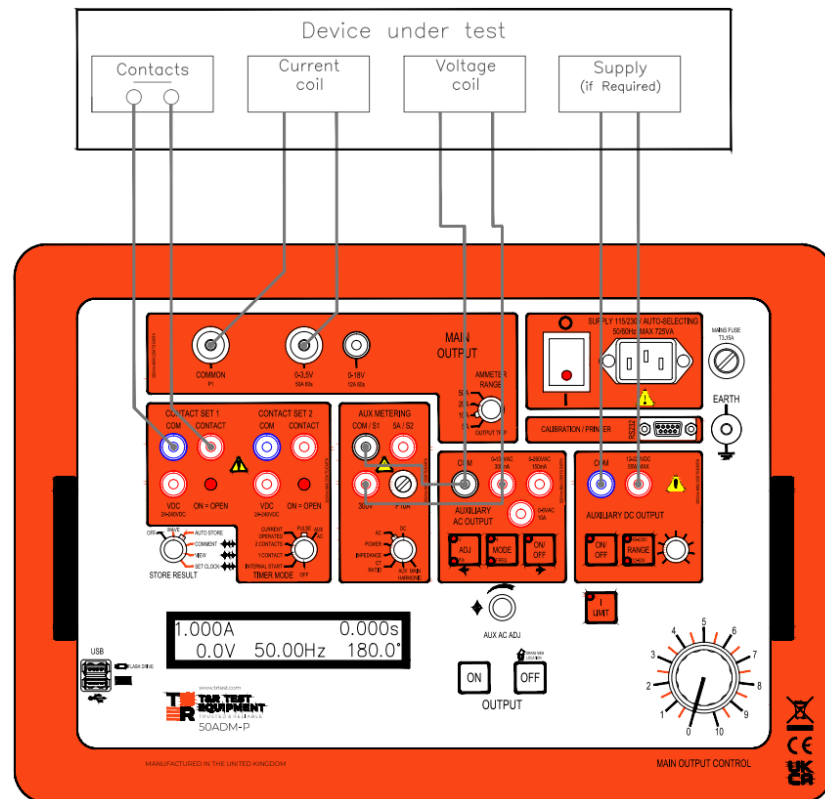

Figure 3.13 Connections for directional overcurrent relay

Ammeter range	As required	Main output on/off	On
Store result	n/a	I limit	On for I<10A
Timer mode	Internal start	Aux ac output adj	V
Aux metering	AC	Aux ac output mode	Φ
Aux dc voltage	If required by relay	Aux ac output on/off	On

Procedure for finding restraint angles

1. Set main current output control to zero (anti-clockwise).
2. Set TIMER MODE to OFF.
3. Switch on main current output and increase to relay I_n .
4. Switch on auxiliary voltage output and increase to relay V_n using AUX AC ADJ.
5. Press ADJ to switch to phase adjust mode (check that F/Φ and Φ LEDs are illuminated). The phase angle may now be rotated using AUX ADC ADJ.
6. Rotate the phase angle and monitor the directional element contact of the relay to see when the relay goes into restraint and comes out of restraint.

Note: To see the effect of the restraint angle immediately the contact input must be connected to a relay contact driven directly by the directional element. If this contact is not available, the overcurrent trip contact must be used, in which case the test current must be high enough to trip the relay and the overcurrent delay must be taken into account.

Procedure for overcurrent timing tests

1. Set the phase angle so the relay is out of restraint.
2. Leave the aux ac voltage switched on and set to this phase angle.
3. Conduct the timing test as detailed in section 3.1.2 or 3.1.3.

3.8 Bias differential relays

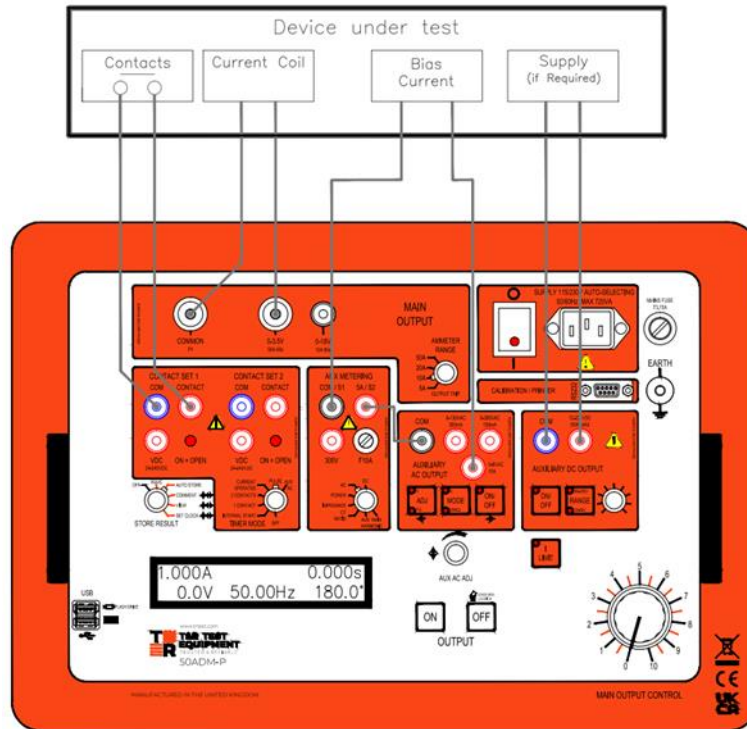

Figure 3.14 Connections for bias differential relays

Ammeter range	Select as required	Main output on/off	On
Store result	n/a	I limit	On for I<10A
Timer mode	Internal start/Aux ac	Aux ac output adj	V
Aux metering	RMS	Aux ac output mode	Φ
Aux dc voltage	If required by relay	Aux ac output on/off	On

Procedure

1. Switch on the aux ac output and increase the current to the required value for the bias coil.
2. Switch on main current output and increase the current to the differential coil until the relay trips.
3. The relay trip point can then be checked against to the relay bias curve.

Continued...

6. The trip time of the relay can be checked by selecting F adjust mode and setting the frequency out of range for relay (e.g. 53Hz for a 50Hz relay). Pressing the MODE button will then toggle the output between mains frequency and the set frequency. When the main output is on, the timer starts when the MODE button is pressed (i.e. when the frequency changes) and stops on a change of contact set 1. Reset the timer by switching the main output off and back on again.

3.11 Induction disk relay run-back time

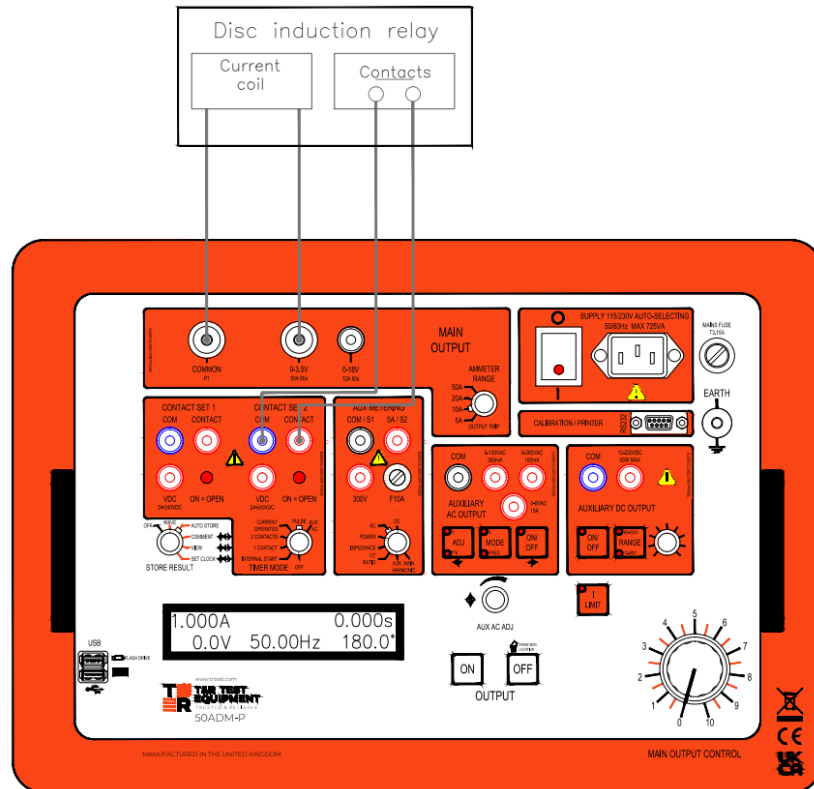

Figure 3.17 Connections for run-back timing

Ammeter range	Select as required	Main output on/off	On
Store result	Off	I limit	On for current <10A
Timer mode	2 contact	Aux ac output adj	n/a
Aux metering	n/a	Aux ac output mode	n/a
Aux dc voltage	As required for relay	Aux ac output on/off	n/a

Procedure

1. Set main current output control to zero (anti-clockwise).
2. Set TIMER MODE to OFF.
3. Switch on main current output.
4. Set the required test current and switch the output off.
5. Set TIMER MODE to 2 CONTACTS.
6. Switch on main output current. The output will come on and the timer will start.
7. When the relay trips the timer result is stored as t0. The output switches off and the timer restarts.
8. The disk will return to its reset position. When it comes to rest, press the OFF button (the accuracy of the test depends on pressing the off button at the moment the disk comes to rest). The timer result is stored as t2.

At the end of the test the AUX AC ADJ knob is automatically put into timer result selection mode (both LEDs off). The AUX AC ADJ knob selects the display of t0 (relay trip time) and t1 (run-back time). The timer results are cleared when the output is switched on for another test.

4. MAINTENANCE



WARNING

Before removing the unit from its case, ensure that the unit is disconnected from the mains. Under no circumstances connect the unit to the mains whilst it is removed from its case.

4.1 Regulator brushes

The regulator brushes should be examined and replaced if necessary. The interval between inspection and renewal of the brushes will depend upon the amount of usage. However, it should be remembered that damage to the regulator can result if the brushes are allowed to wear away to such an extent that a loss of brush pressure occurs.

4.2 Removal of the 50ADM-P from case

To remove the instrument from its case, the following procedure should be used:

- a. Remove visible screws from the edge of the front panel.
- b. Lift the case from the unit.

5. STANDARD ACCESSORIES

5.1 Spares fuses supplied:-

- a. 1 off T3.15A 32mm mains supply.
- b. 1 off F10A 20mm auxiliary supplies.

5.2 Standard accessories supplied

- a. Mains input lead.
- b. 2 off 5m 10mm² output leads.
- c. 2 off 5m 2.5mm² output leads.
- d. 2 off 0.5m 2.5mm² output leads.
- e. 1 off 5m 2 core timer lead.
- f. Operating & Maintenance Manual.
- g. Lead set container.

5.3 Optional accessories/spares

	Part no.
Micro USB keyboard.	A000-0002
USB memory key.	A000-0003
RB10 resistor box.	A192-0006
Replacement output lead set.	A242-0002
Current filter unit.	006

6. PERFORMANCE SPECIFICATIONS

6.1 Accuracy of instrumentation and associated circuit components

6.1.1 Main output ammeter

	Range	Resolution	Accuracy 50Hz	Accuracy 60Hz
True rms ac current	5.000A	0.001A	±0.5% rdg ±5d	±1% rdg ±5d
True rms ac current	10.00A	0.01A	±0.5% rdg ±5d	±1% rdg ±5d
True rms ac current	20.00A	0.01A	±0.5% rdg ±5d	±1% rdg ±5d
True rms ac current	50.00A	0.01A	±0.5% rdg ±5d	±1% rdg ±5d

6.1.2 Auxiliary metering

	Range	Resolution	Accuracy 50Hz	Accuracy 60Hz
AC voltage	0-300.0Vac rms	0.1V	±0.7% rdg ±5d	±1% rdg ±5d
DC voltage	0-300.0Vdc	0.1V	±0.7% rdg ±5d	±1% rdg ±5d
AC current	0-5.000Aac rms* 5-9.999Aac rms**	0.001A	±0.7% rdg ±5d	±1% rdg ±5d
DC current	0-9.999Adc	0.001A	±0.7% rdg ±5d	±1% rdg ±5d
Frequency (V)	40.00-99.99Hz	0.01Hz	±0.05% rdg ±2d	±0.05% rdg ±2d
Frequency (I)	40.00-99.99Hz	0.01Hz	±0.05% rdg ±2d	±0.05% rdg ±2d
Phase (V)	±180.0°	0.1°	±3 degrees	±6 degrees
Phase (I)	±180.0°	0.1°	±3 degrees	±6 degrees

6.1.3 Timing system

Timer mode	Range	Resolution	Accuracy
Internal start	0-999.999s/ 0-9999.99s/ 0-99999.9s	1ms/ 10ms/ 100ms	±0.02% rdg ±2d
Single contact			±0.02% rdg ±2d
Dual contact			±0.02% rdg ±2d
Current operated			±0.02% rdg ±4d
Pulse mode	200ms	1ms	±2ms

7. REVISION

Product / Type: Secondary Current Injection Test Set / 50ADM-P

File: OM0036-G2.doc

Author: G Bond

Issue / Date: G2 / 14.05.25 CCN1837

Modified By: G Bond

Checked By: D Maxim	Date: 14.05.2025
---------------------	------------------

Drawings Required

A2/002154 latest issue